

Laminex New Zealand™  
Fire and Acoustic Floor System  
Installation Manual

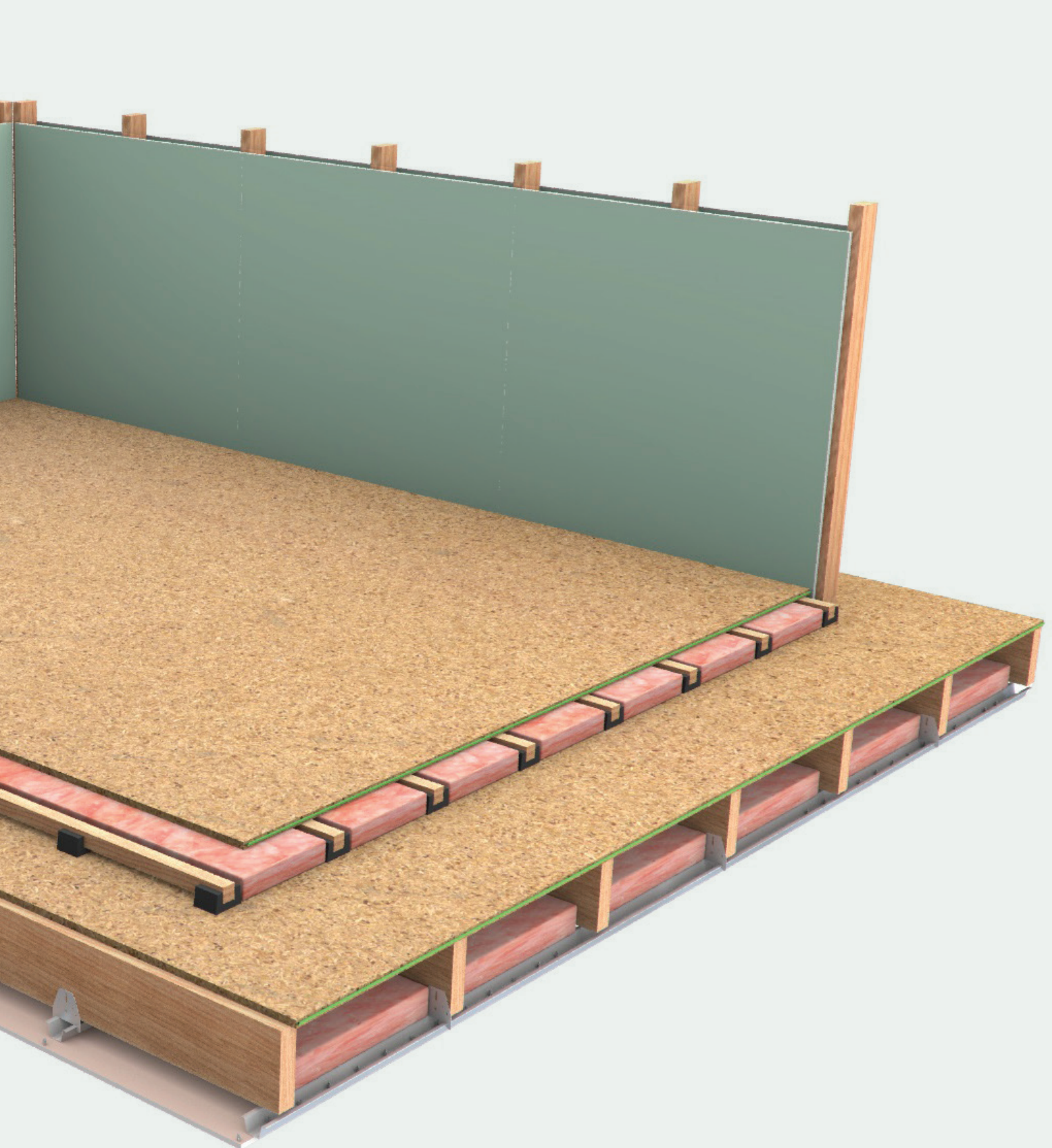

# Contents

		Page
<b>Section 1</b>	<b>Background</b>	<b>02</b>
<b>Section 2</b>	<b>Scope</b>	<b>03</b>
2.1	Specific design, commercial and industrial use	03
2.2	Make sure your information is up to date	03
<b>Section 3</b>	<b>General product description</b>	<b>04</b>
3.1	Strandfloor® Square Edge	04
3.2	Strandfloor® Tongue & Groove	04
3.3	StrandfloorH3.1® Square Edge	05
3.4	StrandfloorH3.1® Tongue & Groove	05
3.5	Strandfloor® characteristic properties	05
3.6	SuperPine® Square Edge	06
3.7	SuperPine® Tongue & Groove	06
3.8	SuperPine® panel tolerances	06
3.9	Accessories	07
<b>Section 4</b>	<b>Durability</b>	<b>08</b>
4.1	Producer statement	08
4.2	BRANZ appraisal	08
4.2.1	Strandfloor®	08
4.2.2	SuperPine®	08
4.3	Durability conditions	08
4.3.1	Handling and storage	08
4.3.2	Weathering	09
4.3.3	Wet areas	09
4.3.4	Heat	09
4.3.5	Prohibited uses	09
<b>Section 5</b>	<b>Installation</b>	<b>10</b>
5.1	Strandfloor® T&G / StrandfloorH3.1® T&G / SuperPine® T&G second layer – Batten & Cradle™ AcoustiFlor™ System	12
5.2	Wet areas	12
5.2.1	Shower tray detail	16
5.2.2	Acrylic shower tray detail	16
5.2.3	Atlantis level entry shower tray detail	18
5.3	Ceiling installation	20
5.4	Floor penetrations	20
5.5	Ceiling penetrations	22
5.6	Cross Laminated Timber (CLT) floor overlay	22
5.7	Concrete floor overlay	24
5.8	GIB® noise control systems intertenancy detail	26

		Page
<b>Section 6</b>	<b>Health and safety</b>	<b>27</b>
<b>6.1</b>	<b>Working conditions</b>	<b>27</b>
6.1.1	Working outdoors	27
<b>6.2</b>	<b>Formaldehyde</b>	<b>27</b>
6.2.1	Control	27
<b>6.3</b>	<b>Safe working practices</b>	<b>27</b>
<b>Section 7</b>	<b>Product warranty</b>	<b>28</b>
<b>7.1</b>	<b>Fire and acoustic system</b>	<b>28</b>
<b>7.2</b>	<b>Ongoing maintenance</b>	<b>28</b>
7.2.1	Floor coverings - wet areas	28
7.2.2	Floor coverings - dry areas	28
<b>Section 8</b>	<b>Tips</b>	<b>29</b>

# 1 Background

Laminex New Zealand™ has developed a lightweight floor system (above joist weight of 30.9kg/m<sup>2</sup> refer to figure 6, page 13) that is suitable for use as intertenancy floor. As per Clause G6 'Airborne and Impact sound' to the New Zealand Building Code (NZBC), the Sound Transmission Class (STC) and the Impact Insulation Class (IIC) for intertenancy floors shall be no less than 55. The Laminex New Zealand™ acoustic floor system has been tested and verified to achieve the fire ratings up to 60/60/60 FRR and STC 65/IIC-56. The acoustic performance exceeds the minimum requirements of Clause-G6 of the NZBC. The acoustic performance of the system has been verified by Marshall Day Acoustics & independently tested at Auckland University and the fire performance has been tested/assessed by BRANZ 394.

To future proof installations during renovation work, acoustic performance can be achieved with no reliance on carpet or acoustic underlay, especially if hardwood flooring or tiles were used.

# 2 Scope

Laminex New Zealand™ Fire and Acoustic Floor System, using Strandfloor®, StrandfloorH3.1® or SuperPine® as per the Installation Manual is suitable for use in dry or wet area applications for buildings within the scope of the NZS 3604, 'Timber-framed buildings' or buildings covered by specific engineering design (SED) with a maximum concentrated load of 3.6 KN over a span of 450mm as per table-3 of AS/NZS 1170.1 Structural Design Actions – Permanent, Imposed and other Actions. Refer to spans and loading tables on page 11.

## 2.1 Specific design, commercial and industrial use

The following information has been specifically designed for Strandfloor® and SuperPine® products. All calculation is based on the requirements and methods details in AS/NZS 1170. Reference to table 3.1 of this standard will give the requirements for particular activities, which can then be aligned with these tables.

This information is by no means exhaustive but covers the common commercial and industrial situations that may occur outside the scope of NZS 3604 and the majority of those within AS/NZS 1170.

All other situations require individual specific design.

## 2.2 Make sure your information is up to date

When specifying or installing Laminex New Zealand™ product, ensure you have the current technical manual. If you are not sure you do, or you need more information, visit [laminex.co.nz](http://laminex.co.nz) or call Laminex New Zealand™ on 0800 303 606.

# 3 General product description



## 3.1 Strandfloor® Square Edge

- o Strandfloor® Square Edge consists of 20mm nominally thick high density reconstituted wood panels.
- o Panels are finished with a square edge.
- o This is a general purpose product intended for all uses.
- o Square edge panels shall always be used when it is intended to clear finish the floor.

Panel dimensions*			
	Panel sizes mm	Weight (kg) per m <sup>2</sup>	Weight (kg) per panel
Square Edge	3600 x 1200 x 20	13.6	58.8
	2400 x 1200 x 20	13.6	39.2



## 3.2 Strandfloor® Tongue & Groove

- o Strandfloor® Tongue & Groove consists of 20mm nominally thick high density reconstituted wood panels, specifically marketed as flooring.
- o This product is identical to Strandfloor® Square Edge in its manufacture but has the addition of a polypropylene white tongue to one long edge, and a groove to the other.
- o When correctly installed this gives the required shear strength and eliminates the need for timber nogs.
- o There is a range of two panel sizes particularly designed for common joists centres.

Panel dimensions*			
	Panel sizes mm	Weight (kg) per m <sup>2</sup>	Weight (kg) per panel
Tongue&Groove	3600 x 1200 x 20	13.6	58.8
	2400 x 1200 x 20	13.6	39.2

\*All dimensions provided are approximate only and subject to manufacturing tolerances.



### 3.3 StrandfloorH3.1® Square Edge

- o StrandfloorH3.1® Square Edge consists of 20mm nominally thick high density reconstituted wood panels, specifically marketed for use in wet areas.
- o The improved resin composition meets the H3.1 treatment requirements, with the added benefit of a 50% increase in exposure time.
- o The added properties are ideal for floors with joists at maximum centres – i.e. 600mm.
- o There are three panel sizes to choose from.

Panel dimensions*			
	Panel sizes mm	Weight (kg) per m <sup>2</sup>	Weight (kg) per panel
H3.1 Square Edge	3600 x 1200 x 20	13.6	58.8
	2400 x 1200 x 20	13.6	39.2



### 3.4 StrandfloorH3.1® Tongue & Groove

- o StrandfloorH3.1® Tongue & Groove consists of 20mm nominally thick high density reconstituted wood panels, specifically marketed for uses in wet areas.
- o This product is identical to StrandfloorH3.1® Square Edge but has the addition of a polypropylene green tongue to one long edge and a groove to the other.
- o When correctly installed this gives the required shear strength and eliminates the need for timber nogs (except in wet areas – refer to section 5 installation).
- o There are three panel sizes to choose from.

Panel dimensions*			
	Panel sizes mm	Weight (kg) per m <sup>2</sup>	Weight (kg) per panel
H3.1 Tongue&Groove	3600 x 1200 x 20	13.6	58.8
	2400 x 1200 x 20	13.6	39.2

\*All dimensions provided are approximate only and subject to manufacturing tolerances.

### 3.5 Strandfloor® characteristic properties

Shear strength			
Product	Property	Parallel	Perpendicular
Strandfloor®	Shear Strength	7.2 MPa	6.45 MPa

**C3.3.3** Refer section 4 – Durability.

**C3.3.4** Refer section 4 – Durability.



### 3.6 SuperPine® Square Edge

- o SuperPine® Square Edge consists of 20mm nominally thick high density reconstituted wood panels.
- o Panels are finished with a square edge.
- o This is a general purpose product intended for all uses other than bathroom and shower areas.
- o Square edge panels shall always be used when it is intended to clear finish the floor.

Panel dimensions*			
	Panel sizes mm	Weight (kg) per m <sup>2</sup>	Weight (kg) per panel
Square Edge	3600 x 1200 x 20	13.8	60
	2400 x 1200 x 20	13.8	40



### 3.7 SuperPine® Tongue & Groove

- o SuperPine® Tongue & Groove consists of 20mm nominally thick high density reconstituted wood panels, specifically marketed as flooring.
- o This product is identical to SuperPine® Square Edge in its manufacture but has the addition of a polypropylene white tongue to one long edge, and a groove to the other.
- o When correctly installed this gives the required shear strength and eliminates the need for timber nogs.
- o There is a range of two panel sizes particularly designed for common joists centres.

Panel dimensions*			
	Panel sizes mm	Weight (kg) per m <sup>2</sup>	Weight (kg) per panel
Tongue&Groove	3600 x 1200 x 20	13.8	60
	2400 x 1200 x 20	13.8	40

\*All dimensions provided are approximate only and subject to manufacturing tolerances.

### 3.8 SuperPine® Panel Tolerances

Panel tolerances	
Length	+/- 1.5mm
Width	+/- 1.5mm
Thickness	+/- 0.2mm
Panel edge straightness	< /=1mm/m on width < /=2mm/m on length.
Panel squareness	The requirement is < /=0.5mm/m. Diagonal of a 2400 is 2683, so the requirement is < 1.25 for a 2400. Diagonal of a 3600 is 3795, so the requirement is < 1.75 for a 3600.



## 3.9 Accessories:

### Accessories not supplied by Laminex New Zealand™.

Laminex New Zealand™ recommends the following products for use in conjunction with its flooring products. Laminex New Zealand™ does not supply these products and does not provide a warranty for their use. Please contact the component manufacturer for information on their warranties and further information on their products.

- o Backing Rod – PEF backing rod to be used with sealant in control joints.
- o Sealant – Sealant used in V joint in tiled applications, ensure the sealant is compatible with the waterproofing membrane system selected.
- o Level/straight edge – For checking straightness of underlying flooring.
- o Waterproofing membrane – Used over the StrandfloorH3.1® Tongue and Groove panel in wet areas. Use the recommended products and applications.
- o Adhesive – Adhesive used over joists prior to installation of Laminex New Zealand™ Strandfloor®
- o Screws for timber – 8g x 45mm wood thread self embedding screws.
- o Screws for steel – 8-10g x 40-45mm wingtek min. class 3 coating.
- o Nails for timber – 60mm annular grooved flooring nails (first layer only).

# 4 Durability

## 4.1 Producer statement

When stored, handled, installed and maintained in accordance with this document, Strandfloor® panels will meet: The durability performance requirements of NZBC B2.3.1 (a) for 50 years.

The specifications, details and methods described herein shall be strictly observed to avoid building code non-compliance.

Laminex New Zealand™ will not be liable to any person if the conditions as to storage, handling, installation and maintenance of Strandfloor® or SuperPine® panels as outlined within this document are not complied with.

**Note:** StrandfloorH3.1® Square Edge and StrandfloorH3.1® Tongue & Groove panels have been treated to resist attack by insects such as borer.

Figure 4.1

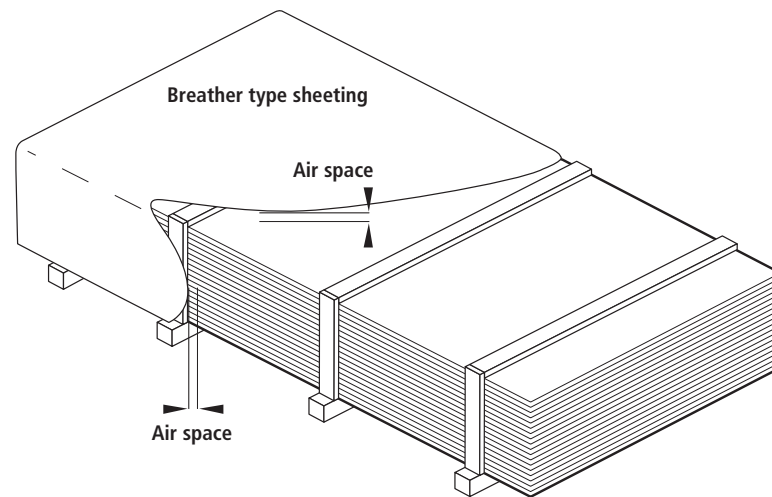

## 4.2 BRANZ appraisal

### 4.2.1 Strandfloor®

- o Strandfloor® has two BRANZ appraisals – Strandfloor® – No.676 (2016) and StrandfloorH3.1® – No. 677 (2016). The current versions of these appraisals are published on the BRANZ website [www.branz.co.nz](http://www.branz.co.nz)

### 4.2.2 SuperPine®

- o SuperPine® has a BRANZ Appraisal, No. 1217 (2022) – covering use within the New Zealand Building Code. The current certificate can be viewed at [www.branz.co.nz](http://www.branz.co.nz)

These BRANZ appraisals confirm that both Strandfloor® and SuperPine® will have a life of at least 50 years.

## 4.3 Durability conditions

The following conditions shall be met; otherwise the durability of the Strandfloor® or SuperPine® will be compromised.

### 4.3.1 Handling and Storage

- o Panels shall be stored and handled so as to minimise surface and edge damage.

- o Wherever possible panels shall be stored inside under cover. Outside storage shall be for short periods only. Panels shall not be stacked on wet concrete floors.
- o The panels shall be flat stacked clear of the ground, on evenly placed, full width, level bearers. Bearers shall be of uniform thickness and shall extend across the full width of the stack (refer figure 5.1).
- o When stored in external situations, panels shall be protected from the weather. A breather-type cover shall be used, supported clear of the top sides of the panels using battens to allow air to circulate freely around the pack (refer figure 4.1).

#### 4.3.2 Weathering

- o Strandfloor® Square Edge and Strandfloor® Tongue & Groove shall not be exposed to weathering for more than eight weeks.
- o StrandfloorH3.1® Square Edge and StrandfloorH3.1® Tongue & Groove shall not be exposed to weathering for more than 12 weeks.
- o Panel properties maybe affected by moisture saturation and/or exposure to sub-zero temperatures.
- o During the exposed period, do not allow water to pond on the surface. Remove water by sweeping and forming small holes adjacent to plate lines. Do not directly cover panels with sheeting or apply liquid sealers to any surface. Panels should weather in their raw condition to allow release of absorbed moisture.

#### 4.3.3 Wet areas

- o Strandfloor® H3.1 Tongue & Groove  
Wet areas shall comply with NZBC E3 / A51 or E3 / A52.
- o In “wet areas”, panels shall be protected with a suitable wet area membrane or an integrally waterproof sheet material. Refer to Strandfloor® Technical Manual, Section 9: Finishing – 9.3 Wet areas.
- o Strandfloor® Tongue & Groove / SuperPine® Tongue and Groove  
Provided strict criteria is met, Strandfloor® Tongue & Groove or SuperPine® Tongue & Groove can be used in kitchens and laundries. For more information, refer to the respective Technical Manual of each product. These can be downloaded at laminex.co.nz

#### 4.3.4 Heat

- o Panels shall be separated from fuel burning appliances, flues and chimneys in accordance with NZCB Section C AS/1.
- o Panels shall not be subjected to temperatures exceeding 50°C for a prolonged period.

#### 4.3.5 Prohibited uses

- o Panels shall not be used in covered exteriors situations with no weather protection e.g. open verandas.
- o Once installed and in use, panels shall not be subjected to conditions that will allow the continuing moisture content to be above 16%.

**C4.3.2** The “weather exposed” period includes the time that the panels are in an exposed condition when being transported or stored on site without covering. Panels will respond to changes in humidity and moisture content. Some grain raising may result. Loss of stiffness and strength can occur if panels are exposed to sub-zero conditions whilst saturated – i.e. ski lodges. If the exposure period cannot be met, then panels shall be post laid (once the structure is enclosed). Alternatively, sheet covering may be used providing it is indirect and adequate air space is maintained (“tent” effect).

**C4.3.3** A “wet area” is any area within a building supplied with water from a water supply system, e.g. kitchens, bathrooms, toilets, shower rooms, laundries, changing rooms, ensuites, etc.

**C4.3.4** Over floor and under floor type heating systems may be used with Strandfloor® or SuperPine® products providing the operating temperature does not exceed 35°C and the panel moisture content is less than 16%. The heating system manufacturer must be consulted prior to installation.

# 5 Installation

Figure 1 First Layer Installation

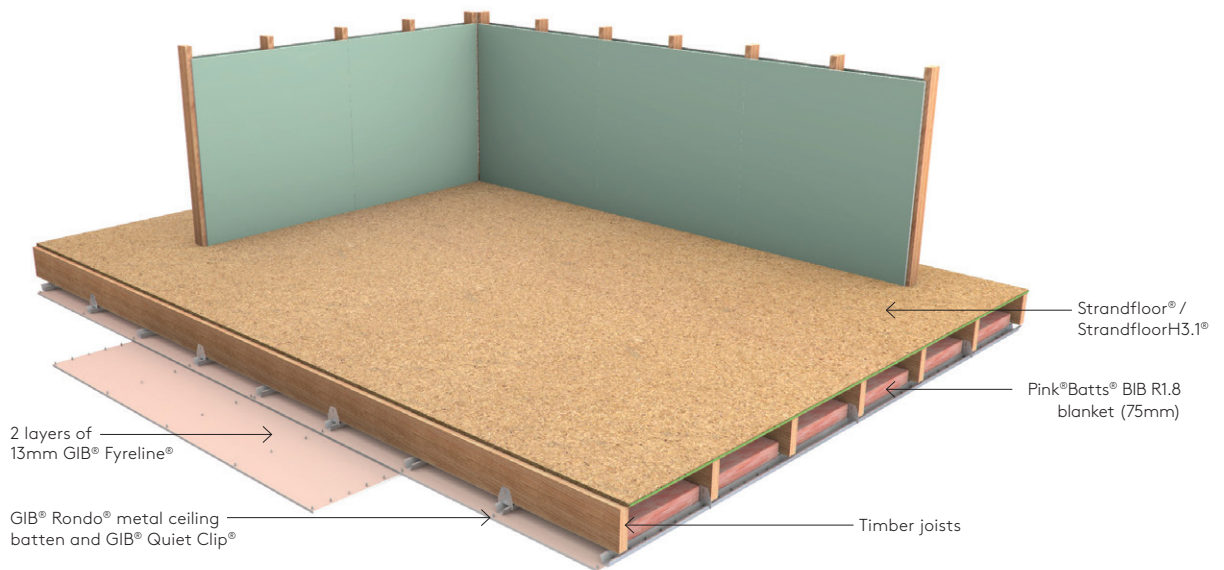

Laminex New Zealand™ Fire and Acoustic Floor System is built using the standard floor construction methodologies used in lightweight timber frame building construction. The floor system uses two layers of Strandfloor® or SuperPine®, the first layer fixed to the timber floor joists and the second layer fixed into wooden battens over a rubber cradle creating a floating floor.

Strandfloor® or SuperPine® over joists:

- o Refer to the Strandfloor® Technical Manual or SuperPine® Technical Manual for detailed information regarding installation.
- o Solid timber joists sizes can be selected as per the NZS 3604 design tables.
- o Alternatively engineered wooden I-Beams / floor joists can also be used for the construction of this floor system.
- o A bead of adhesive e.g. Sturdi Bond Alpha Grip or Gorilla Grip be applied over the joists before fixing the sheets.
- o The long sheet edges are manufactured with a tongue and groove edge. The long sheet edges are to be buttoned to form a tight tongue and groove joint. Tap the sheets tight using a wooden block along the edge to avoid damaging the edge.
- o Run Strandfloor® / StrandfloorH3.1® / SuperPine® across the floor joists and fix flooring sheets using annular grooved nails 60mm annular grooved flooring nails, 60mm galvanised jolt head nails, or they can also be screwed fixed using a 45mm x 8g timber thread self-embedding screws to floor joists at centres as per table 5.1 (refer to fastener table 5.1 on page 11).

After the floor installation has been completed, the construction above the floor should be carried out as per the normal practice. Once the internal walls have been completed with internal lining, the installation of the second layer of Strandfloor® / StrandfloorH3.1® / SuperPine® can commence.

Table 5.1

Fastener types						
Timber Joists (includes SG8, LVL8 & I-Beams)	Minimum size	Fixing centres mm		Diaphragm (NZS3604)		
		Perimeter	Intermediates	Strandfloor (T&G/SE)	SuperPine T&G	SuperPine SE
Annular Grooved particleboard flooring nails (NZ Nails*)	60mm x 3.1	150	200	✓		✓
Galvanised jolt head nails (NZ Nails*)	60mm x 2.8 / 3.1	150	200	✓		✓
Self drilling screws corrosion resistant (Bremick*)	45mm x 8 gauge	150	200	✓		
Simpson Strongtie SS Screw	50mm x 10 gauge (SSWSC2BSA10)	150	200	✓		
Simpson Strongtie Zinc Screw	50mm x 10 gauge (WSV50SA)	150	200	✓	✓	✓
Beck Scrail SubLok Pro	57mm x 2.8 gauge	150	200	✓		
Delfast Shank Nail	50mm x 2.8 gauge	150	200	✓		
<b>Steel Joists</b>						
Self drilling corrosion resistant Tek screws	45mm x 10g Tek	150	200			

\*Approved for SED diaphragm floors.

Table 5.2

Adhesive Options		
Timber Joists	Sika Nailbond® Premium	5mm continuous bead to the top of each joist and between sheets at ends and edges, 2mm bead to the top of the tongue.
	Bostik Alpha Grip	
	Gorilla Grip	
	HB Fuller Sturdi Bond™	
Steel Joists	Sikaflex® 123 MS Bond	
	Gorilla 940FC	
	Gorilla MS Sealant	

Note: Check with adhesive supplier to ensure adhesives not listed are suitable.

## 5.1 Strandfloor® T&G / StrandfloorH3.1® T&G / SuperPine® T&G second layer – Batten & Cradle™ AcoustiFlor™ System

- o Position the AcoustiFlor™ cradles on the floor starting from one edge of the room. The cradles allow the placement of Batten & Cradle™ AcoustiFlor™ structural battens.
- o Acoustic cradles must be placed at 450mm centres maximum along the length of Batten, and Batten rows at 400mm centres. Minimum requirements are 7 cradles/m<sup>2</sup> of the floor area (refer figure 4).
- o AcoustiFlor™ Cradles and structural battens are placed along the perimeter of the room with a 10mm gap from the internal lining (refer figures 3 and 7).
- o Place the AcoustiFlor™ structural battens into the Acoustic cradle. The maximum spacing between the AcoustiFlor™ structural battens must not exceed 400mm centres. The battens can run in either direction of the room i.e. independent of the floor joists or Strandfloor® T&G / StrandfloorH3.1® T&G / SuperPine® T&G layout.
- o Ensure battens are level by placing packers / shims in the rubber cradles where necessary to prevent floor spring (no gap between the battens & cradles).
- o Acoustic insulation 50mm / 75mm thick (density 9.6kg/m<sup>3</sup> minimum) must be placed in between the batten and cradles to create a damping effect (refer figure 5).
- o For battens or joists greater than 40mm in height (i.e. 75mm - 140mm), insulation must fill a minimum 75% of the cavity height - 100mm joist = 75mm insulation thickness.
- o Lay Strandfloor® T&G / StrandfloorH3.1® T&G / SuperPine® T&G across the batten and fix to the battens using a 45mm x 8g self-tapping steel screws. Fixing centres are 150mm for sheet perimeter and 200mm centre of sheet (intermediate area) (refer figure 2).
- o The long sheet edges are to be butted together to form a tight tongue and groove joint (refer figure 6).
- o Allow a 5-8mm gap between the Strandfloor® T&G / StrandfloorH3.1® T&G / SuperPine® T&G and the wall lining around the perimeter. The gap is filled with a PEF rod and sealed with acoustic sealant (refer figures 6, 7 & 10).
- o Gluing of Strandfloor® T&G / StrandfloorH3.1® T&G / SuperPine® T&G panels to AcoustiFlor™ structural battens is not mandatory.

Residential - Retail and Commercial (office) spans and Loadings			
Batten row centres	400mm		
Cradle centres	450mm		
Batten size mm	42mm x 30mm	42mm x 40mm	42 x 75mm / 140mm
Uniform loads (kPa)	3.0	4.0	4.0
Concentrated loads (kN)	2.7	3.6	3.6

## 5.2 Wet areas

For installation of StrandfloorH3.1® in wet areas follow details as described in 5.1 above, and if rigid floor coverings (e.g. ceramic tile), are being installed please follow details below:

- o A suitable tile & slate fibre cement sheet underlay and the application of an appropriate waterproof membrane shall be installed over the Strandfloor® prior to installation of rigid floor coverings, such as ceramic tile (refer to figure 6 & 7).
- o In wet areas, StrandfloorH3.1® panels shall be covered with a floor covering or finish that is impervious (i.e. does not allow the passage of moisture).

While Acceptable Solution E3/AS1 provides a list of impervious surface finishes that meet the requirements of the NZBC, Laminex New Zealand™ believe that the laying of an appropriate (1) wet area membrane in accordance with E3/AS2 and the Code of Practice for Internal Wet Area Membranes prior to the installation of any decorative surface, is best practice to ensure the StrandfloorH3.1® T&G will remain dry for the life of the structure.

**C5.1** Refer to Laminex New Zealand™ Strandfloor® Technical Manual Wet Areas 9.3.2 and SuperPine® Technical Manual 2.3.1 Kitchens | Laundries for details on impervious floor finishes.

Figure 2 Fixing detail

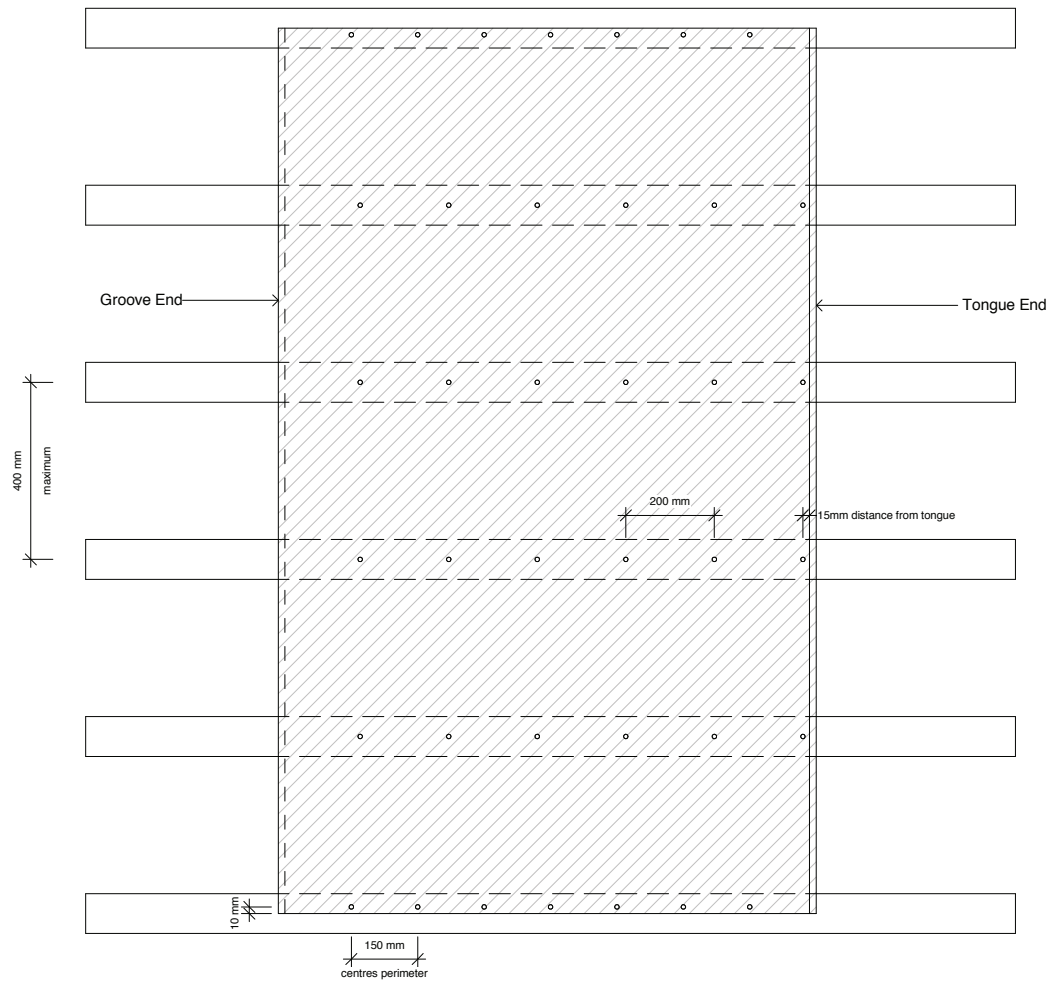

Figure 3 Strandfloor® / SuperPine® Joist Layer Installation

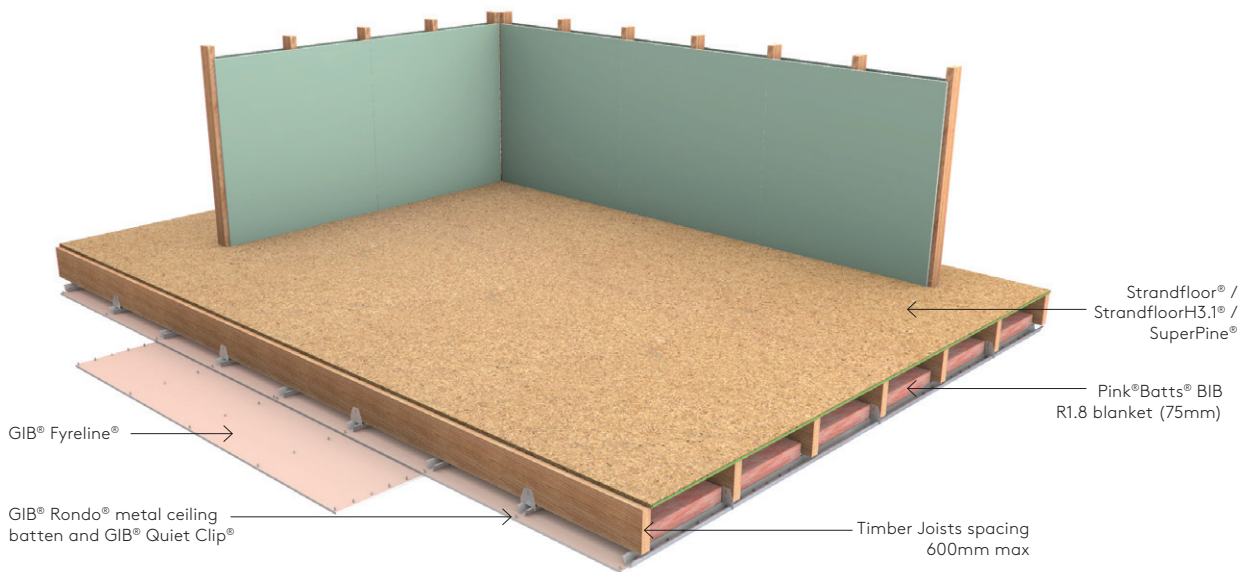

Figure 4 AcoustiFlor™ Batten & Cradle™ set up

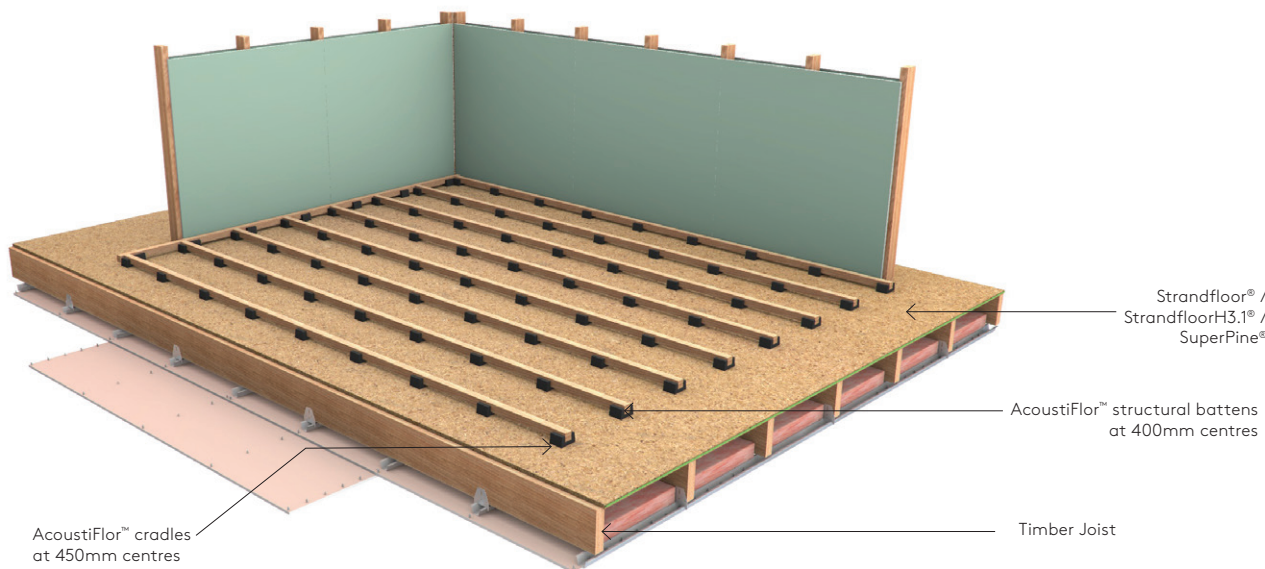

Figure 5 75mm thick insulation, density of 9.6kgs /m<sup>3</sup> minimum

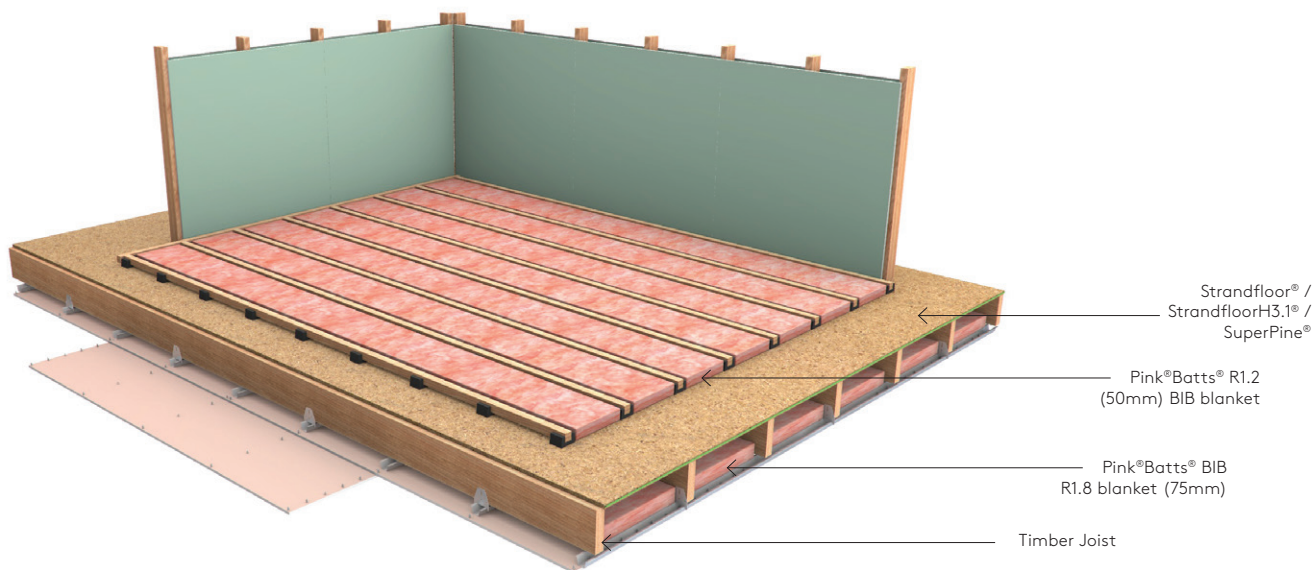
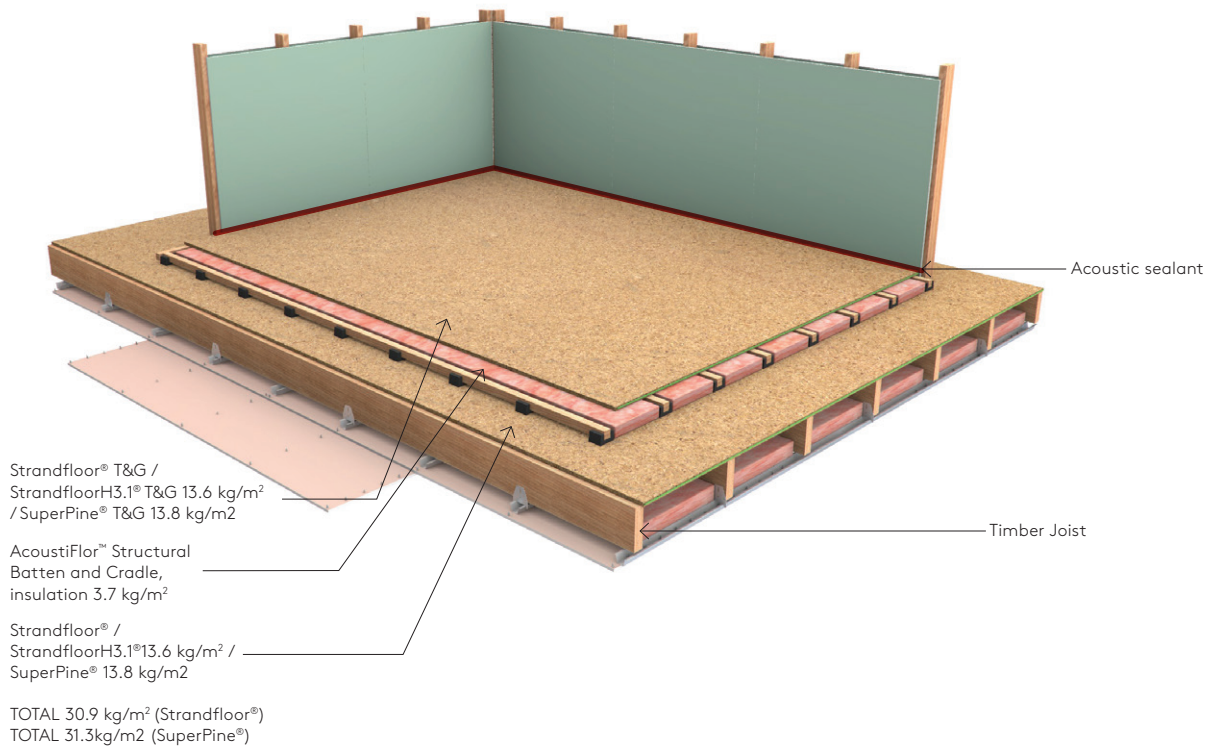

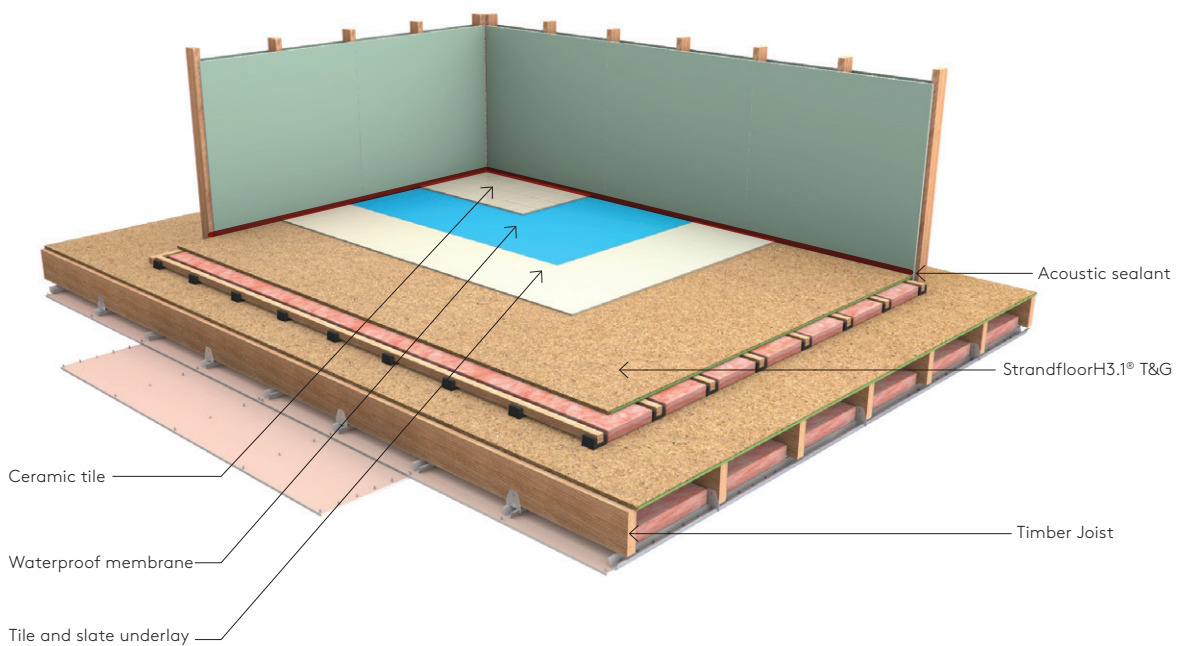

Figure 6 Strandfloor® / SuperPine® second layer installation



Note: SuperPine® is only suitable for residential floor loads (not retail or commercial).

Figure 7 StrandfloorH3.1® Wet Area



### 5.2.1 Shower tray detail

Please refer to Laminex New Zealand™ Strandfloor® Technical Manual section 9.3 for further wet area installation details.

### 5.2.2 Acrylic shower tray detail

Refer figures A, B, C, D

Figure A Services running parallel to floor joists

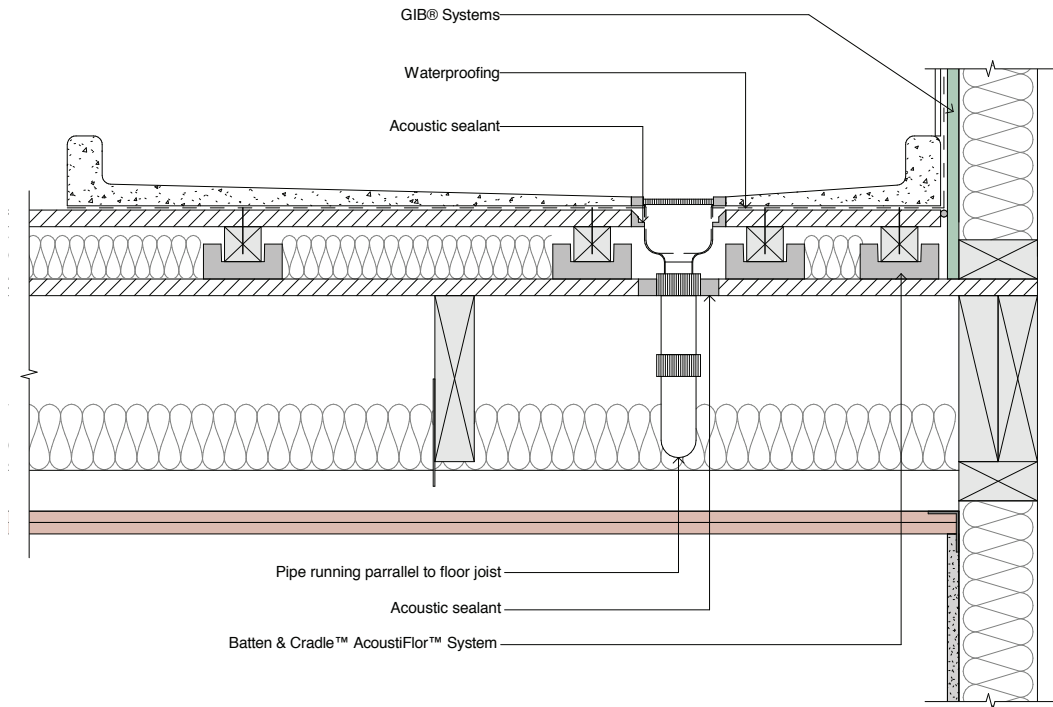

Figure B

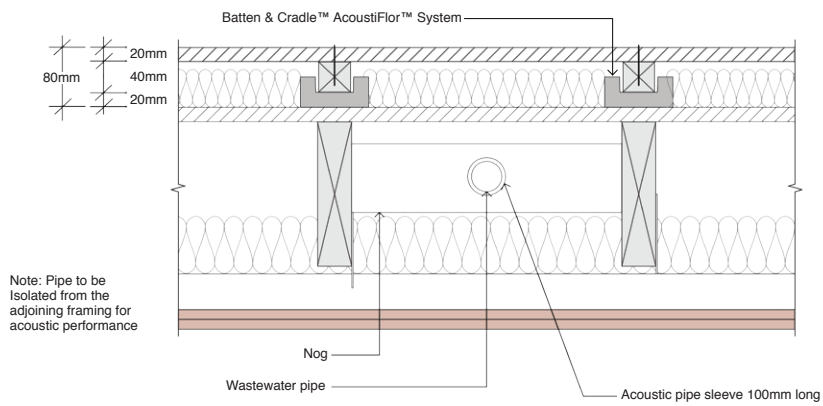

Figure C Services running through floor joists

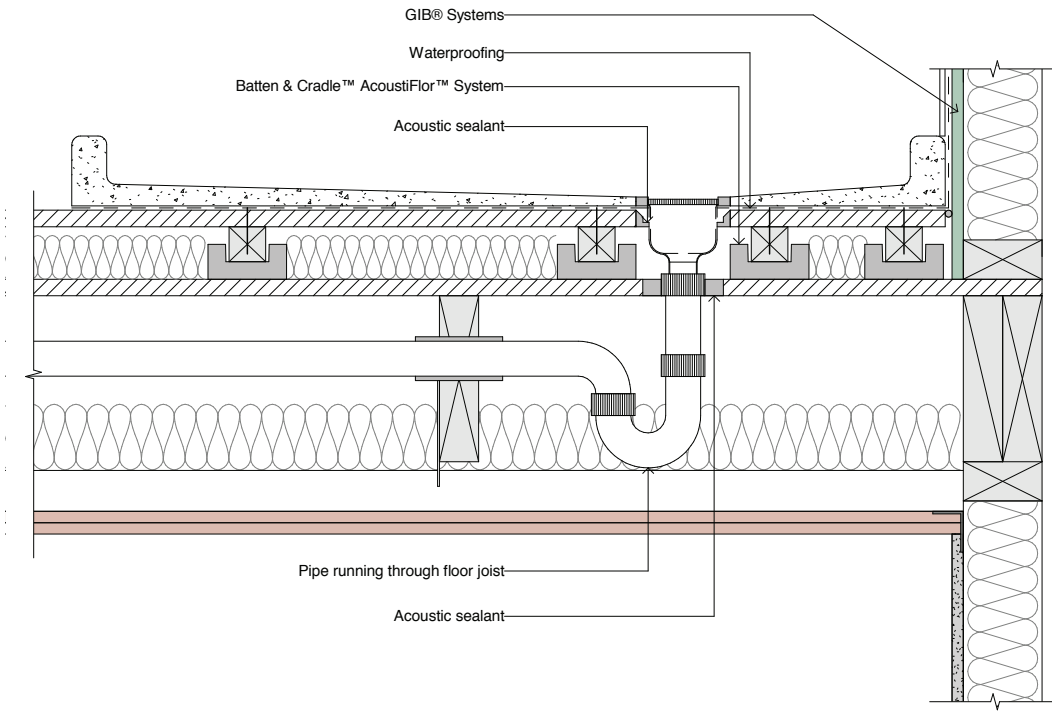
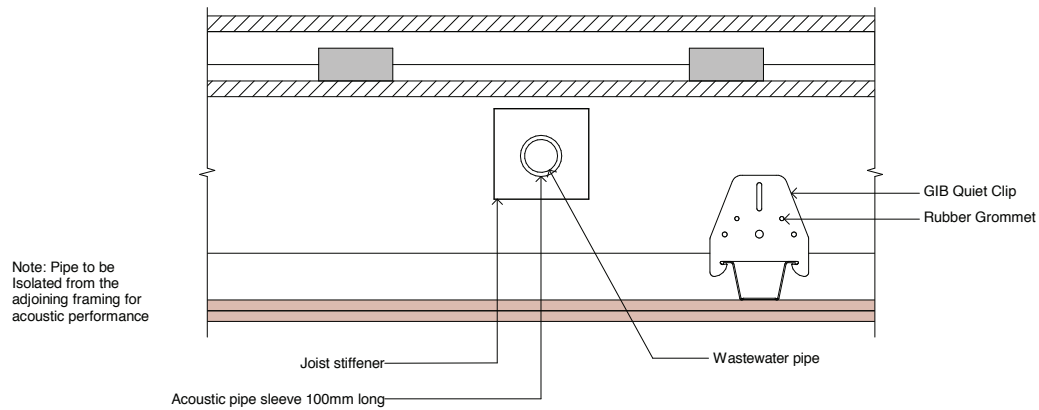

Figure D



### 5.2.3 Atlantis level entry shower tray detail

Refer figures E, F, G, H.

Atlantis have developed a level entry shower base system which provides a solution for a waterproof join at the shower base and Strandfloor® junction. This allows for the installation of rigid floor covering, such as ceramic tiles and other impervious floor coverings where level entry is desired. For further details on the Atlantis level entry shower base please contact Atlantis.

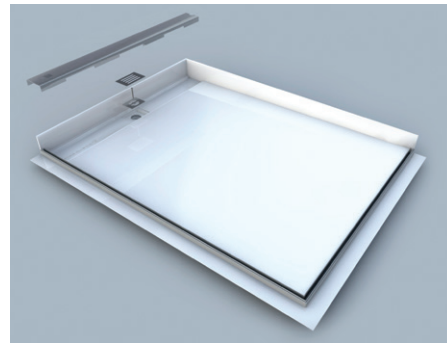

### Atlantis Linea Quattro Tiled Channel Drain Shower System

100% waterproof, structurally solid preformed FRP base. 100mm high upstand from the floor and 65mm waterproofing flange at front of the tray for secure waterproofing connection. Factory-fitted glass receiver channels on base. Includes new aquaPLANE™ waste for optimal drainage. Over 60 Standard sizes available. Contact Atlantis for details: Call 0800 428 526 or visit [www.atlantis.net.nz](http://www.atlantis.net.nz).

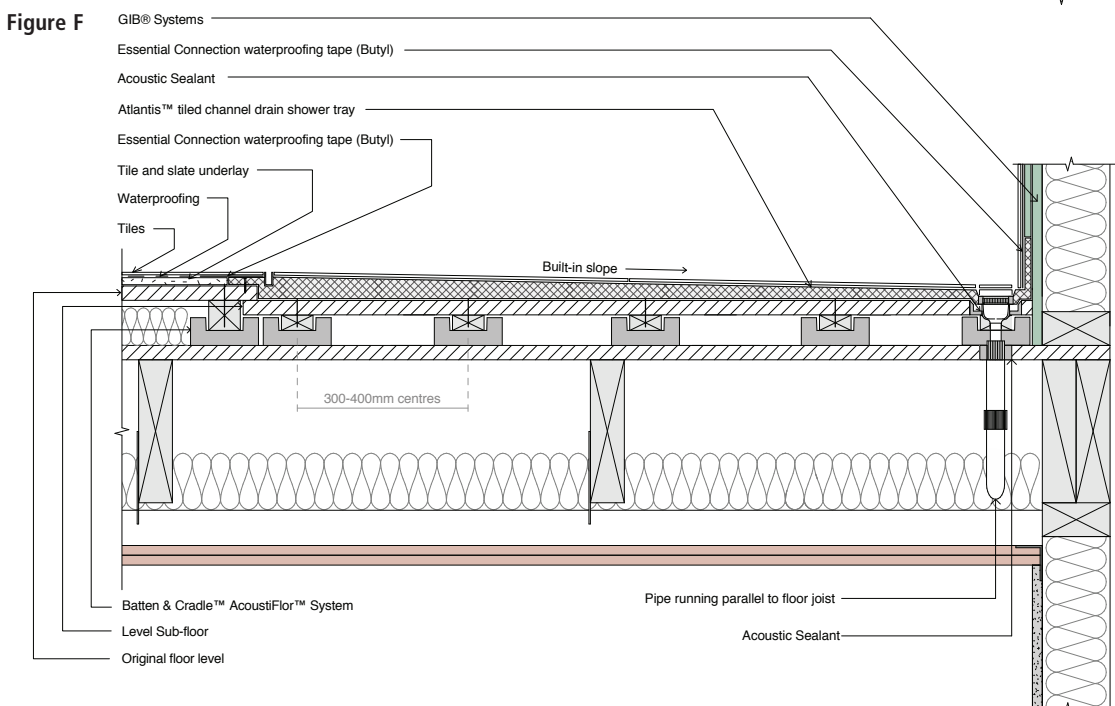
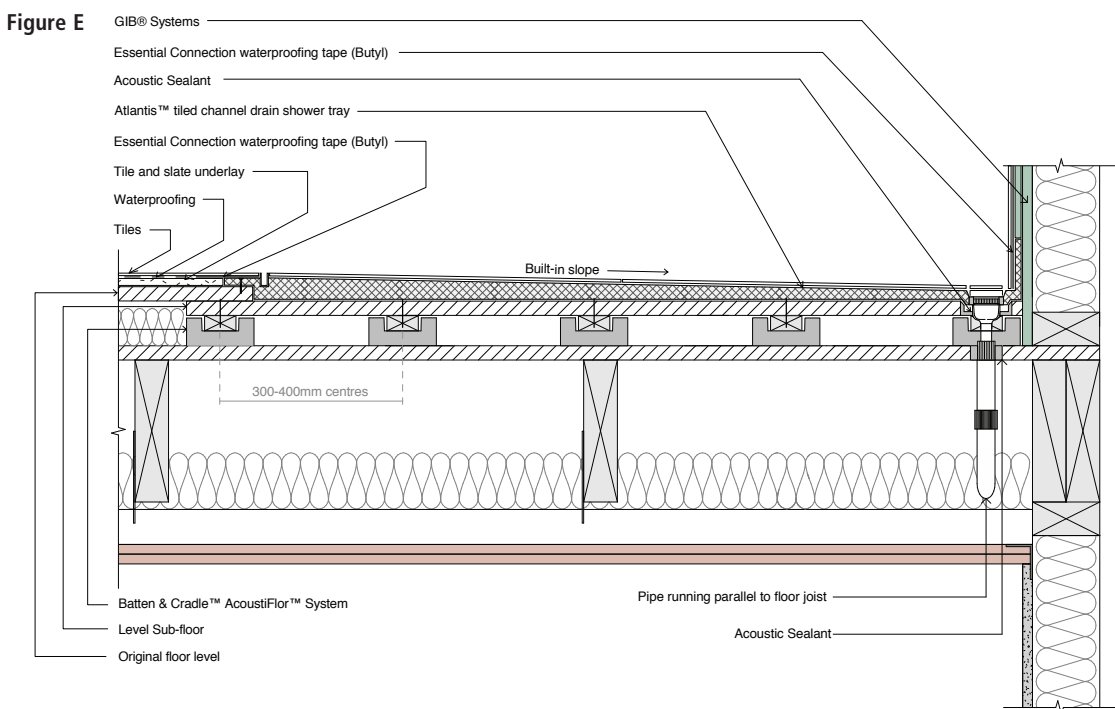

Figure G

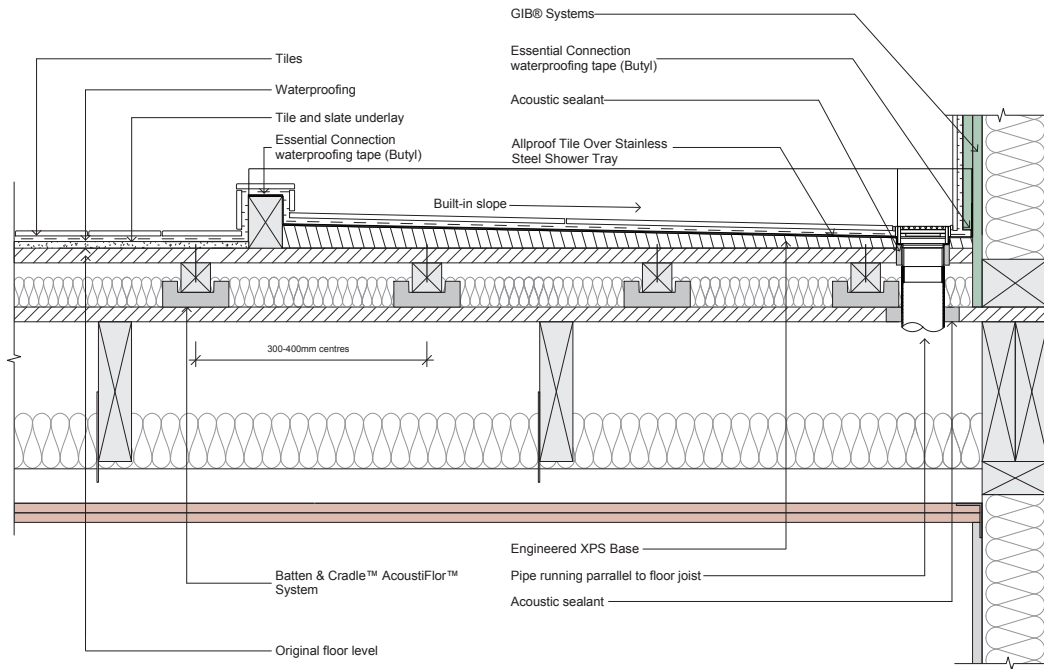
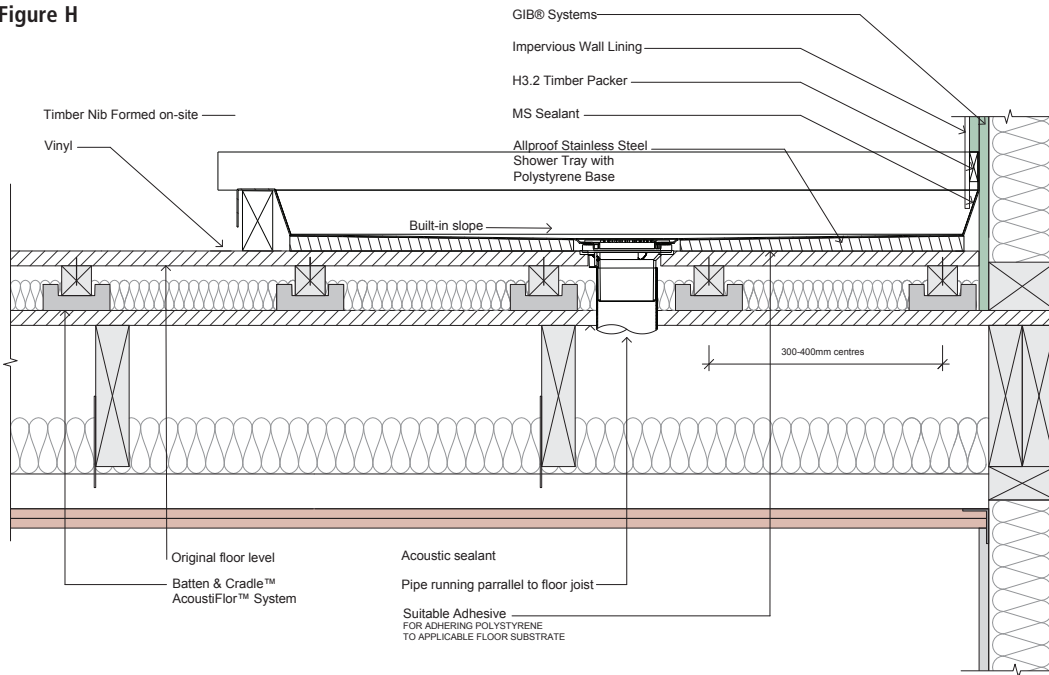

Figure H



## 5.3 Ceiling installation

The installation of the GIB® Quiet Clip®, GIB® Rondo® metal ceiling batten and 2 x 13mm GIB® Fyrelite® is as per the information published by Winstone Wallboards Limited. Refer to GIB® Noise Control® Systems technical specification for information regarding their installation.

## 5.4 Floor penetrations

For smooth clean cut circular holes:

- o For pipe penetrations through the floor cut a 10mm oversize hole through the Strandfloor®. Fit the pipe through the penetration and then seal around with an acoustic sealant.

For irregular holes:

- o Use of a jigsaw or reciprocating saw.
- o Small rectangle or circular holes can be cut by drilling a series of small holes around the perimeter of the hole then tapping out the waste from the sheet face.

### Pipe Penetration Details – Structural Support

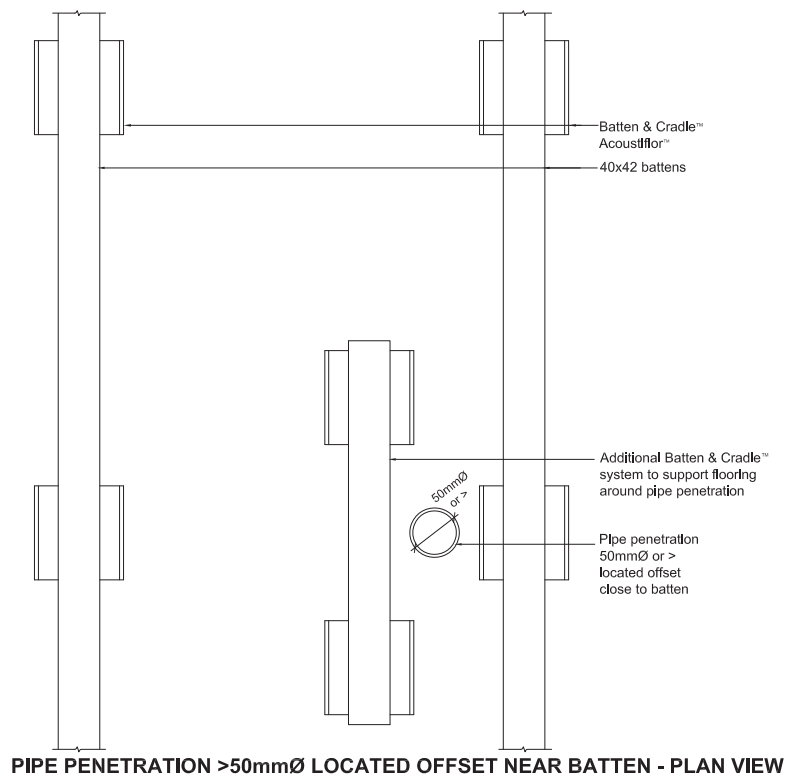

Note:  
Representative Example of Structural Detail  
Please refer to Batten & Cradle "Acoustiflor"™, Technical Department for any further options needed

Pipe Penetration >50mmØ Located offset near batten – Plan view

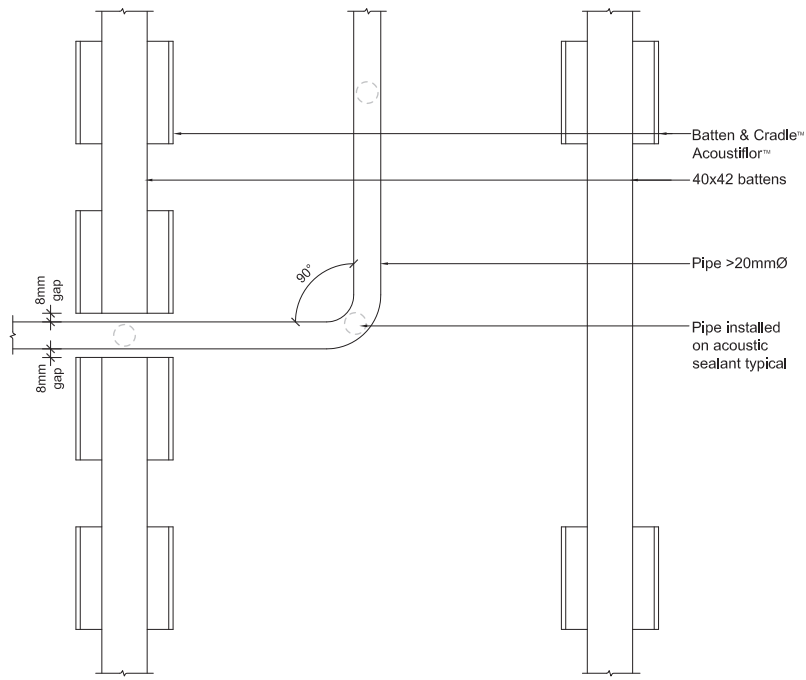

**PIPE >20mmØ - PLAN VIEW**

Pipe >20mmØ – Plan view

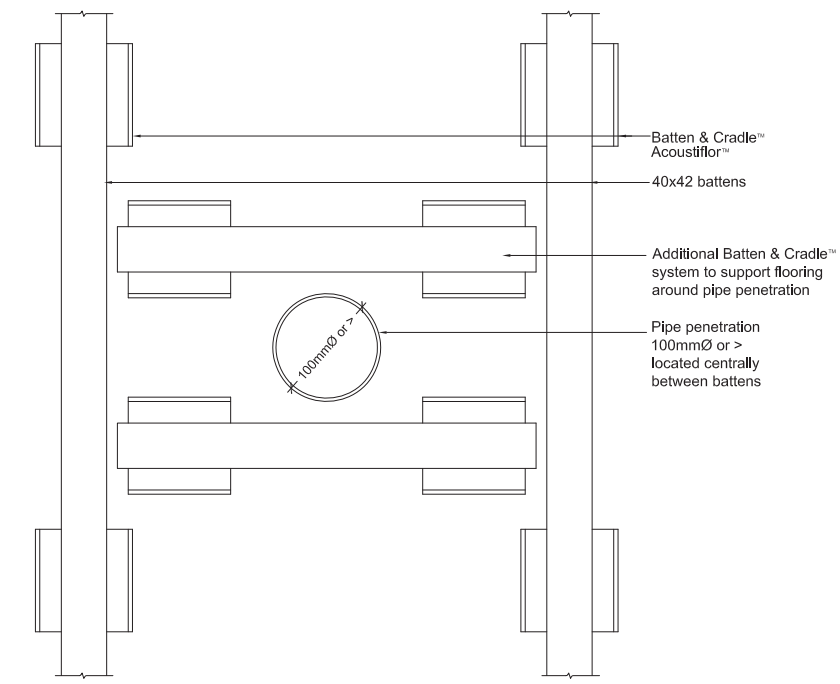

**PIPE PENETRATION >100mmØ LOCATED CENTRALLY - PLAN VIEW**

Pipe Penetration >100mmØ Located centrally – Plan view

## 5.5 Ceiling penetrations

Penetrations through a fire rated system, if they are not correctly specified, installed and tested, can allow spread of fire and smoke from one fire cell to another.

As a general guidance Gartner Superlux Limited have tested several light fittings in conjunction with GIB® Fyrelite® for use in fire rated ceiling application. Based on this testing they publish information for their light fittings as to what is the maximum surface area allowed and minimum distance to be maintained between the light fittings.

It is suggested that the information published in 'GIB® Fire Rated systems' specification and Gartner Superlux Limited is referred to before specifying any penetrations through a fire rated ceiling. Also check with the proprietary seals manufacturer/supplier for the installation details of their products and its test data.

## 5.6 Cross Laminated Timber (CLT) floor overlay

Install Batten & Cradle™ AcustiFlor™ system over Cross Laminated Timber (CLT) floors as per Strandfloor® / StrandfloorH3.1® T&G / SuperPine® T&G second layer installation details in section 5.1.

Figure 8 Batten Layer





Figure 9 Strandfloor® / SuperPine® Layer

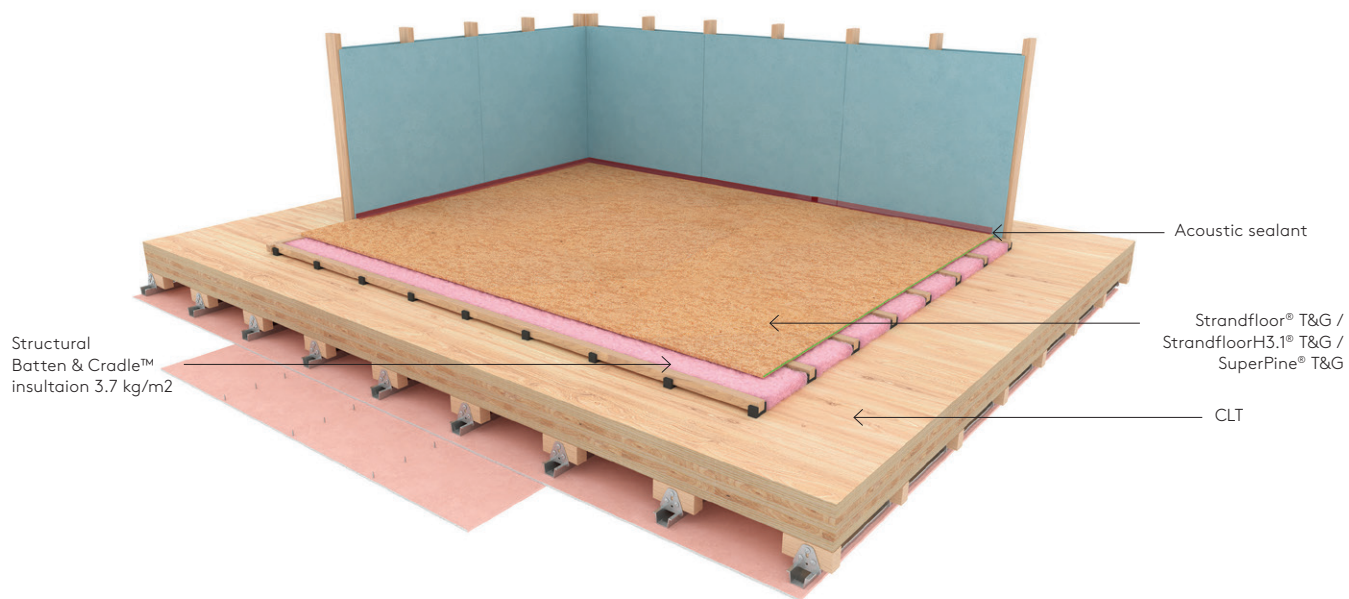

For further information regarding this system, visit [redstagtimber.co.nz](http://redstagtimber.co.nz)

## 5.7 Concrete floor overlay

Install Batten & Cradle™ AcustiFlor™ system over concrete floors as per Strandfloor® T&G / StrandfloorH3.1® T&G / SuperPine® T&G second layer installation details in section 5.1.

The concrete overlay systems have various values dependent on floor and slab combinations refer to table:

Floor											
Ceiling		120 mm Hibond (average concrete thickness 90 mm)		75 mm Unispan + 75 mm topping		200 mm Dycore with 65 mm topping		120 mm Stahlton Rib and Infill (minimum concrete thickness 135 mm on 25 mm timber infills)		90 mm Interspan (minimum concrete thickness 90 mm on 25 mm timber infills)	
Thickness/ layers	Cavity Insulation Present?	Impact Insulation Class	L' <sub>nt,w</sub> (+C <sub>1</sub> ) (See Note 1)	Impact Insulation Class	L' <sub>nt,w</sub> (+C <sub>1</sub> ) (See Note 1)	Impact Insulation Class	L' <sub>nt,w</sub> (+C <sub>1</sub> ) (See Note 1)	Impact Insulation Class	L' <sub>nt,w</sub> (+C <sub>1</sub> ) (See Note 1)	Impact Insulation Class	L' <sub>nt,w</sub> (+C <sub>1</sub> ) (See Note 1)
No plasterboard ceiling	N/A	IIC 57	53 (+0) dB	IIC 64	46 (+1) dB	IIC 65	45 (+0) dB	IIC 62	48 (+0) dB	IIC 58	52 (+0) dB
1 x 10 mm plasterboard	No	IIC 54	53 (+1) dB	IIC 59	45(+3) dB	IIC 60	44 (+3) dB	IIC 58	48 (+1) dB	IIC 55	52 (+1) dB
	Yes	IIC 63	42 (+2) dB	IIC 66	37(+4) dB	IIC 67	36 (+4) dB	IIC 67	39 (+2) dB	IIC 64	41 (+2) dB
1 x 13 mm plasterboard	No	IIC 58	48 (+2) dB	IIC 63	40 (+3) dB	IIC 64	40 (+3) dB	IIC 62	43 (+2) dB	IIC 59	47 (+2) dB
	Yes	IIC 74	34 (+1) dB	IIC 77	28(+2) dB	IIC 78	27 (+2) dB	IIC 78	30 (+1) dB	IIC 75	33 (+1) dB
2 x 13 mm plasterboard	No	IIC 62	43 (+3) dB	IIC 67	36(+4) dB	IIC 68	35 (+4) dB	IIC 65	39 (+2) dB	IIC 63	42 (+3) dB
	Yes	IIC 78	32 (+0) dB	IIC 81	26(+1) dB	IIC 82	24 (+2) dB	IIC 82	28 (+0) dB	IIC 79	31 (+0) dB

Figure 10 Concrete Mid Floor

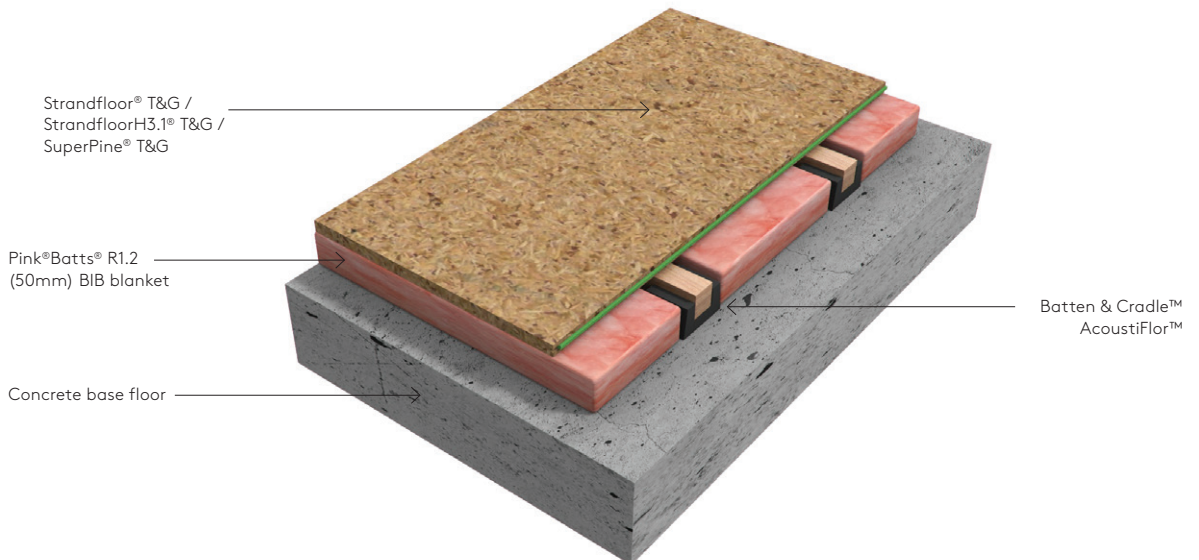

Figure 11 Concrete Mid Floor detail

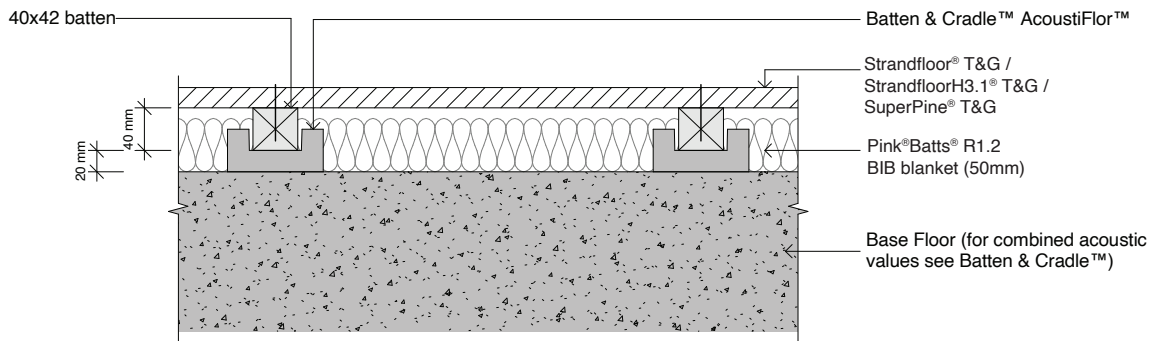

Figure 12

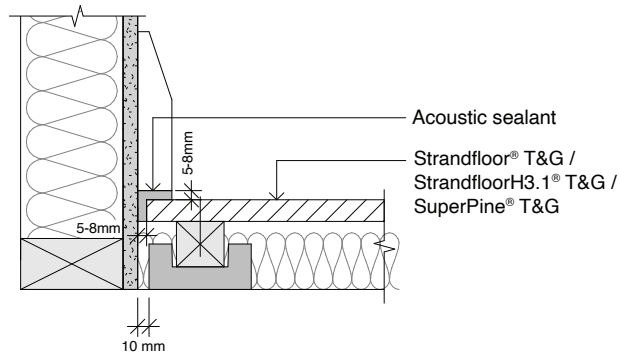
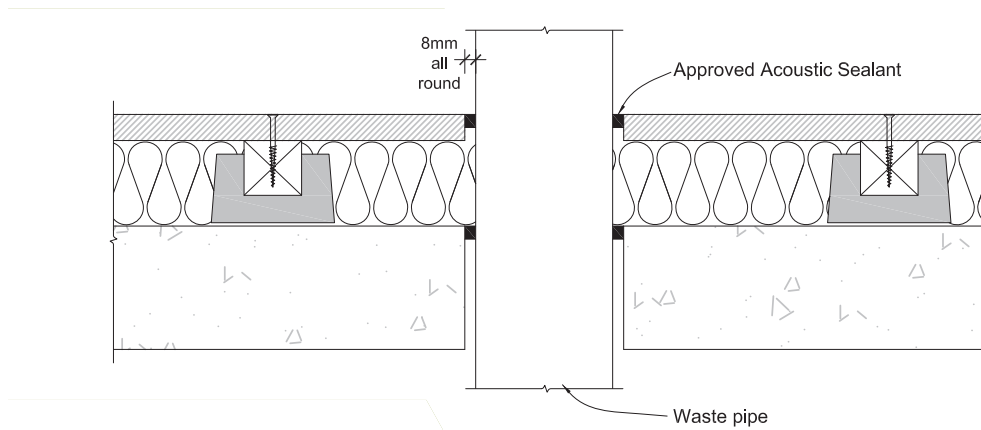

Figure 12a



NOTE:  
All penetrations must be approved by a Registered Acoustic Engineer, to either eliminate, mitigate or manage acoustic layout that could lead to a degradation of the acoustic ability to the system.

## 5.8 GIB® Noise Control® Systems intertenancy detail

Refer to GIB® manual for GBDA 60e.

Refer to system specification number GBDA 60e in the GIB® Noise Control® Systems Manual IIC\* - 56 (\*refer GIB® Noise Control® Systems Manual for further detail) FRR – 60/60/60.

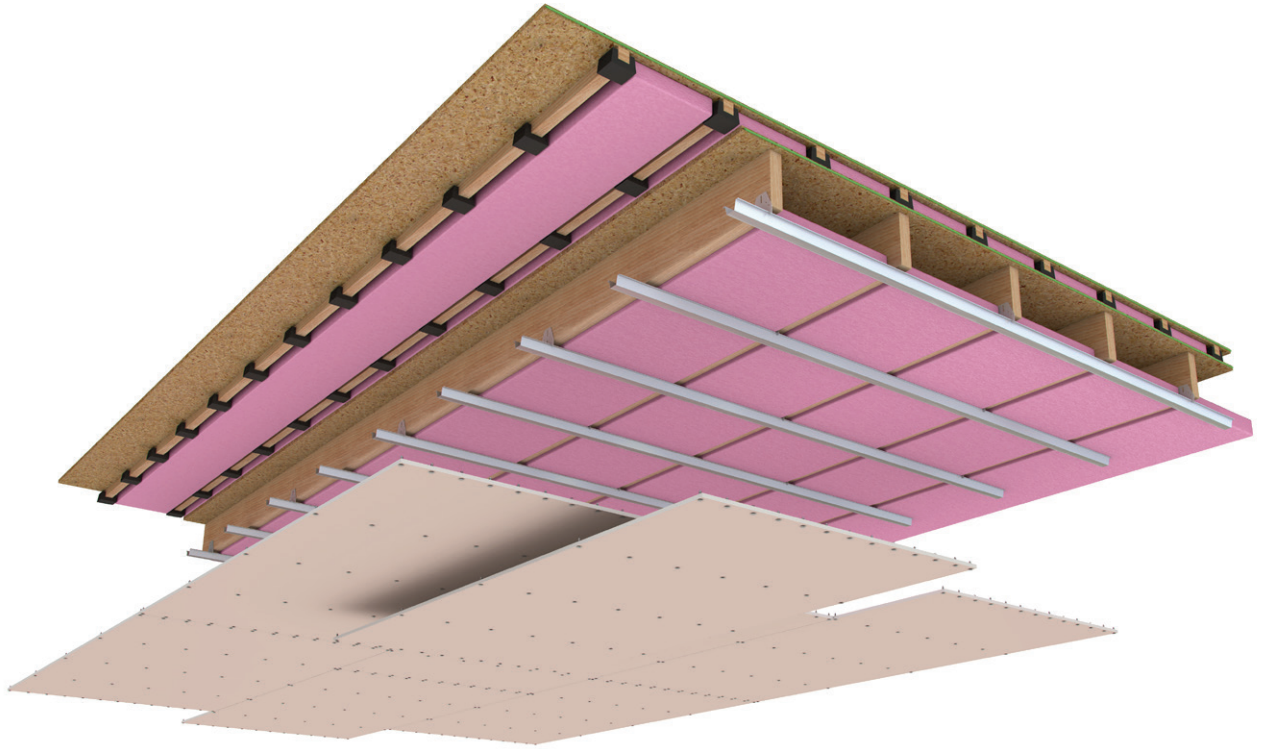
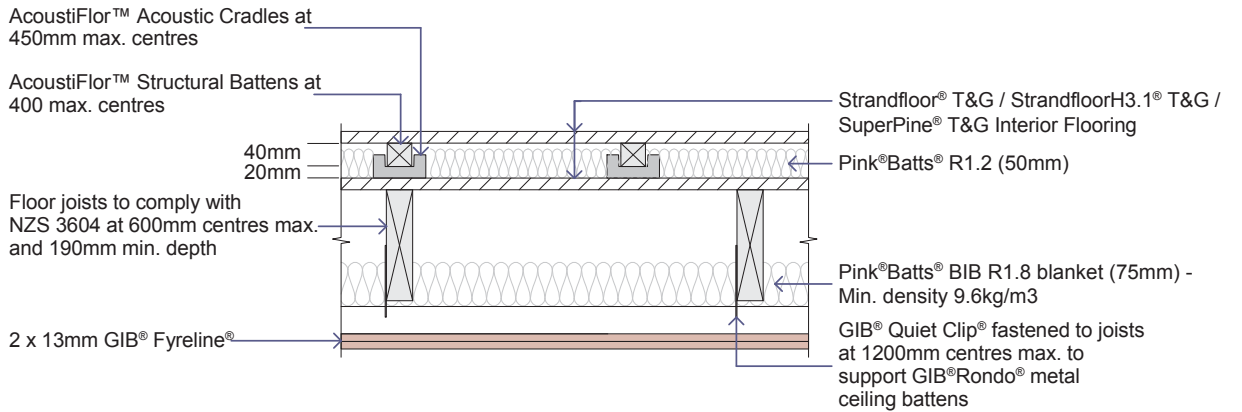

Figure 13



# 6 Health and safety

## 6.1 Working conditions

- o Health and Safety precautions shall be taken when working with wood panel products.
- o Exposure to wood dust and/or formaldehyde may cause irritation to eyes, respiratory system and skin, and may cause sensation resulting in asthma, and by skin contact resulting in dermatitis.
- o Wood dust is classified as a known carcinogen. Repeated inhalation of wood dust over many years may cause cancer. Formaldehyde is classified as a known carcinogen.
- o Storage areas containing large quantities of Strandfloor® / SuperPine® shall be adequately ventilated.
- o Work areas shall be well ventilated and kept clean.
- o Sawing, sanding and routing equipment should be fitted with dust extractors such that dust levels are kept within standards outlined by Worksafe Australia, Worksafe New Zealand or the specific country of use. If not, wear a Dust Mask conforming with AS/NZS 1715 and AS/NZS 1716 and eye protection conforming with AS/NZS 1337.
- o Offcuts, shavings and dust shall be disposed of in a manner that avoids the generation of dust and in accordance with the requirements of local waste authorities.
- o In end use applications all product surfaces exposed to occupied space shall be sealed.

### 6.1.1 Working outdoors

- o Make sure you work in a well ventilated area.
- o Position cutting station so wind will blow dust away from yourself and others in the working area.
- o When sawing, sanding, rebating, drilling or machining wood panels, always:
  - o Wear your P1 or P2 mask (correctly fitted in accordance with manufacturers' instructions).
  - o Wear safety glasses.
  - o Wear hearing protection.
  - o When others are close by ask them to do the same.

If concerns still exists about exposure levels or you do not comply with the above practices, you should always consult a qualified industrial hygienist.

## 6.2 Formaldehyde

### 6.2.1 Control

When installed, emission levels can be controlled by room ventilation and covering of the surface. The surface shall be sealed or covered with a coating system or alternatively, with a floor covering such as foam-backed carpet, carpet with rubber underlay, sheet vinyl or ceramic tiles.

Sealing or covering of the surface shall be carried out before the building is occupied.

## 6.3 Safe working practices

- o Never use a power saw in a poorly ventilated area.
- o Always use M class extractor unit as a minimum.
- o Always use an approved sharp sawblade when cutting wood panels.
- o Always follow tool manufacturers' safety recommendations.
- o Always wear an approved properly-fitted approved dust mask (P1 or P2).

# 7 Product warranty

## 7.1 Fire and acoustic system

Refer to the GIB® Product and System Warranty - <https://www.gib.co.nz/assets/Uploads/GIB-Product-and-System-Warranty-August-2019.pdf>

## 7.2 Ongoing maintenance

The occupier or owner, throughout the life of the building, shall maintain the following specific area.

### 7.2.1 Floor coverings - Wet areas

- o Floor coverings in wet areas, shall be maintained to ensure water cannot penetrate through to the StrandfloorH3.1®. To ensure long-term performance of the flooring, the surface protection system shall be repaired at any sign of damage.
- o Floor wastes shall remain unobstructed and drain to the outside of the building.

### 7.2.2 Floor coverings - Dry areas

- o Other floor coverings and coatings shall be maintained to ensure the Strandfloor® / SuperPine® surface is protected.

# 8 Tips

## For estimating purposes:

- o 0.8 Man hours per M2 is required to install the system
- o 7 cradles per M2
- o 2.8 Lineal Metres of timber batter per M2
- o The shape, size and location of the floor could also impact the price.

VISIT US

[laminex.co.nz](https://laminex.co.nz)

CALL US

0800 303 606

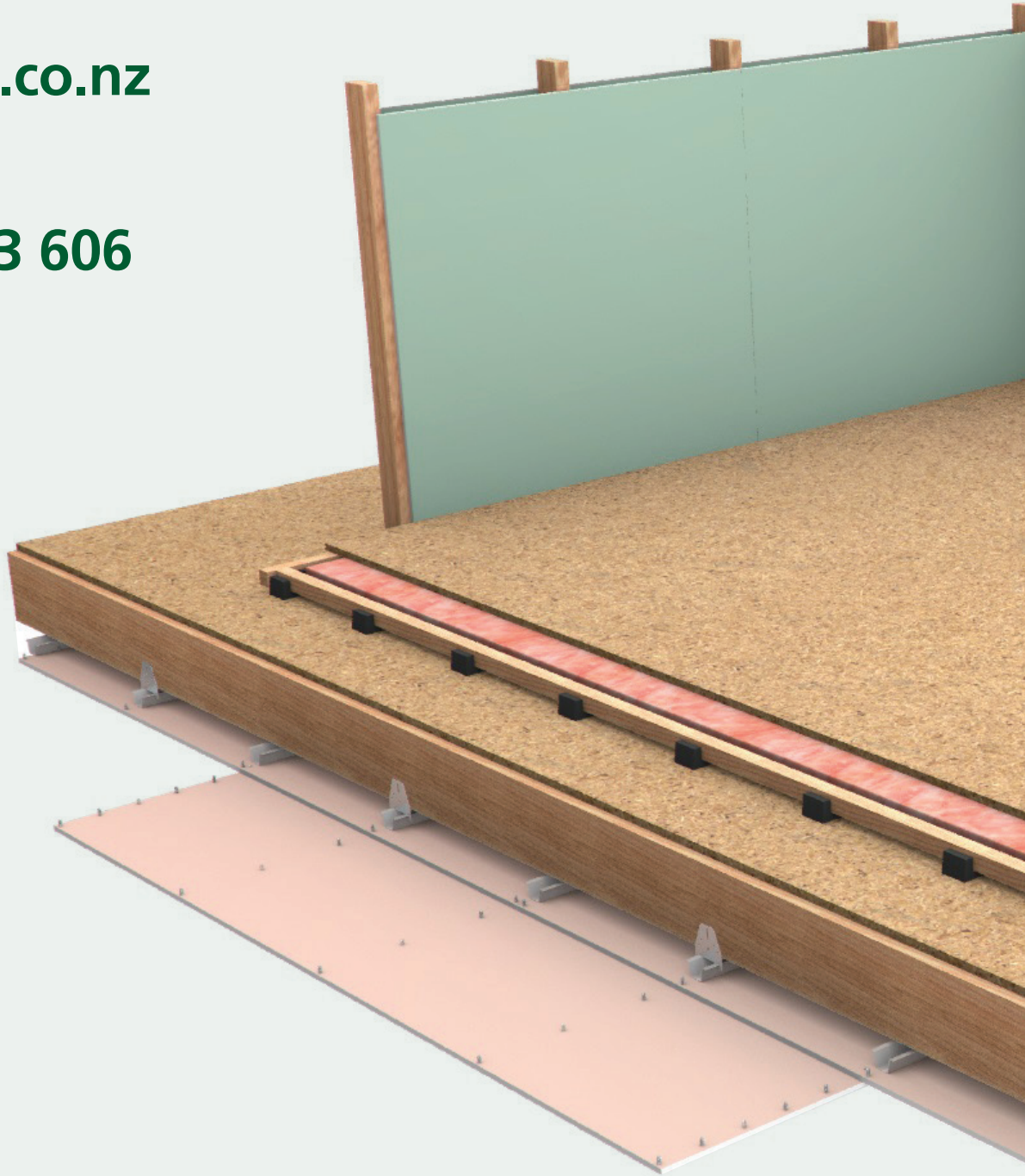

J010329 - 10/22

© Copyright 2022 Strandfloor®, Strandfloor® logo, Strandfloor® Square Edge, Strandfloor® Square Edge logo, StrandfloorH3.1®, StrandfloorH3.1® logo, Strandfloor® Tongue & Groove, Strandfloor® Tongue & Groove logo, StrandfloorH3.1® Tongue & Groove, StrandfloorH3.1® Tongue & Groove logo, StrandfloorH3.1® Square Edge, StrandfloorH3.1® Square Edge logo, SuperPine®, SuperPine® logo, SuperPine® Square Edge, SuperPine® Square Edge logo, SuperPine® Tongue & Groove and SuperPine® Tongue & Groove logo are trademarks of Fletcher Building Holdings and used under licence by Laminex New Zealand™, a division of Fletcher Building Products Ltd. Laminex New Zealand™ and Trade Essentials are trademarks used under licence by Laminex New Zealand™, a division of Fletcher Building Products Ltd.

**Laminex**<sup>™</sup>  
NEW ZEALAND