



Batten & Cradle™
Flooring Systems

SPECIFIERS GUIDE



Supplied under license by



 **Batten & Cradle**™
Flooring Systems



Turning old tyres into new floors

Supplied under license by

 **SYSTEMS**
INTERNATIONAL LTD
"Delivering Certainty"

CONTENTS

INTRODUCTION	2
BATTEN & CRADLE™ FLOORING SYSTEM	
Concrete Structure	4
Wooden Structure	15
DEKCRADLE	
Product Information	42
Datasheet	46
WARRANTIES / INSTALL MANUAL	
AcoustiFlor	51
DekCradle	52
Installation Manual	54
TEST RESULTS	
Acoustic Testing Reports	62
Opinion on Impact Insulation Rating of Batten & Cradle™ Flooring Systems with Steel Battens - Aug 2016	68
Opinion on Impact Insulation Rating of Batten & Cradle™ Flooring Systems - April 2014	74
Opinion on Impact Insulation Rating of Scyon® Secura™ Interior Flooring on Batten & Cradle™ Flooring Systems - June 2013	82
Opinion on Impact Insulation Rating of Scyon® Secura™ Interior Flooring on Batten & Cradle™ Flooring Systems with a Villaboard® Ceiling - June 2013	92
2010 Opinion on Impact Insulation Rating of Batten & Cradle™ Flooring Systems - June 2010	103
FIELD TEST	114
BRANZ TESTS	125





This specifiers guide has been developed by B&C Systems International to assist designers and specifiers in creating quieter living environments. This manual is helpful in selecting the most suitable acoustic solution for your application.

Our Batten & Cradle™ Flooring Systems are BRANZ certified and independently tested to meet and exceed building standards.

Manufactured from recycled tyres, our acoustic cradles are moulded to a high specification using fully blocked resins similar to those used in children's safe fall playgrounds.

Timber used in our systems is sourced from sustainably grown forests.

Our flooring systems cater to a wide range of applications and are suitable for new builds and refurbishment projects in commercial, domestic, healthcare and educational applications.

When specifying Batten & Cradle™ products, ensure you have the current information. Please refer to our website for any changes and additions to all or any of our technical information. We recommend you check to ensure you are using the most current technical information before proceeding.

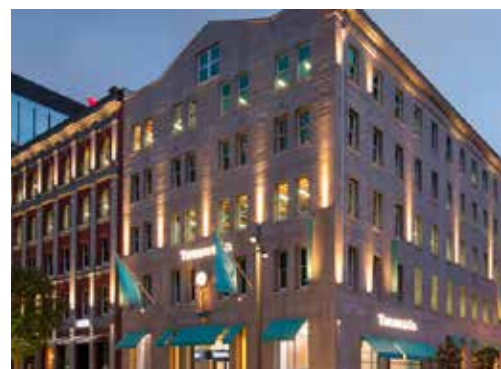

www.battenandcradle.co.nz
www.battenandcradle.com.au





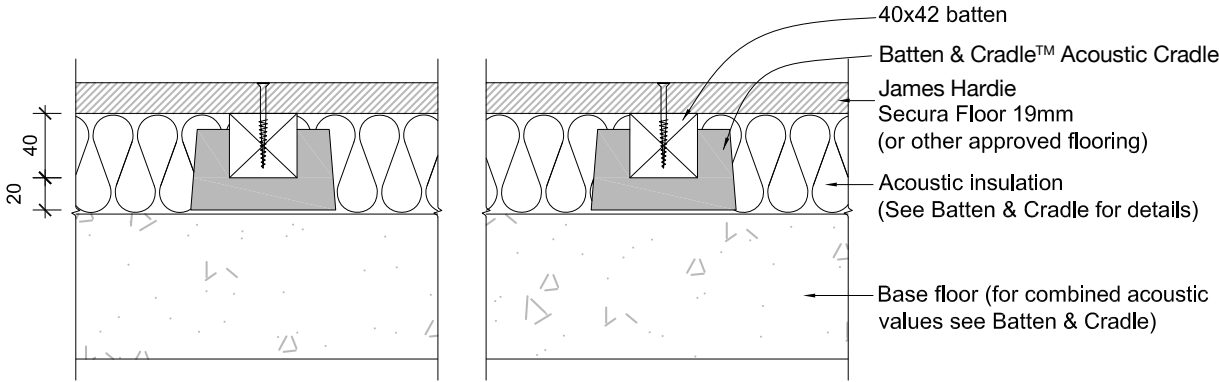
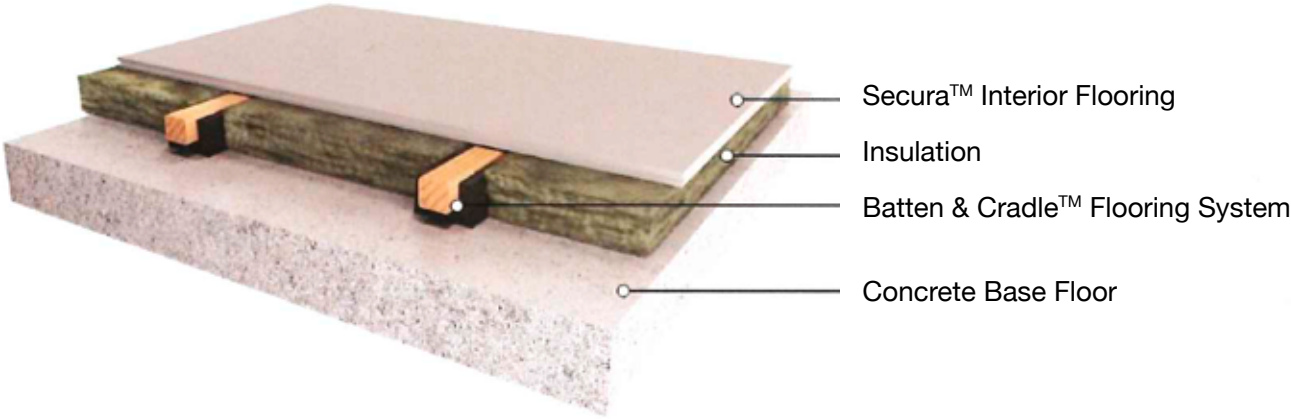

- Note:
- Batten & Cradle™ Acoustic Cradle
 - Acoustic Insulation
 - James Hardie Secura Floor 19mm (or other approved flooring)

Standard steel battens available - 40mm
 Other sizes available on request

The following table details the expected impact performance of floor system B as described in Section 2.0 with various ceiling and floor slab combinations, including whether cavity insulation is installed. As per Marshall Day June 2013 report on James Hardie Secura Floor.

The following table details the expected impact performance of floor system B as described in Section 2 with various ceiling and floor slab combinations, including whether ceiling cavity insulation is installed:

Table 2: Batten and Cradle™ – Bare Floor – With cavity Infill – Impact Insulation Prediction

Thickness /layers	Ceiling		Floor			
	120 mm Hibond (average concrete thickness 90 mm)	75 mm Unispan + 75 mm topping	200 mm Dycore with 65 mm topping	120 mm Stahiton Rib and Infill (minimum concrete thickness 135 mm on 25 mm timber infills)	90 mm Interspan (minimum concrete thickness 90 mm on 25 mm timber infills)	
	Impact Insulation Class (See Note 1)	Impact Insulation Class (See Note 1)	Impact Insulation Class (See Note 1)	Impact Insulation Class (See Note 1)	Impact Insulation Class (See Note 1)	$L'_{nt,w} (+C_1)$
No plasterboard ceiling	IIC 57	IIC 64	IIC 65	IIC 62	IIC 58	52 (+0) dB
1 x 10 mm plasterboard	IIC 54	IIC 59	IIC 60	IIC 58	IIC 55	52 (+1) dB
	IIC 63	IIC 66	IIC 67	IIC 67	IIC 64	41 (+2) dB
1 x 13 mm plasterboard	IIC 58	IIC 63	IIC 64	IIC 62	IIC 59	47 (+2) dB
	IIC 74	IIC 77	IIC 78	IIC 78	IIC 75	33 (+1) dB
2 x 13 mm plasterboard	IIC 62	IIC 67	IIC 68	IIC 65	IIC 63	42 (+3) dB
	IIC 78	IIC 81	IIC 82	IIC 82	IIC 79	31 (+0) dB

Notes: 1. The $L'_{nt,w} (+C_1)$ has been calculated based on a receiving room volume of 50 m³. No allowance has been made for on-site flanking transmission.
 2. Refer to Section 2.0 for construction information in relation to Table 1 above.

Note: This document may be reproduced in full but not in part without the written consent of Marshall Day Acoustics Limited
 J:\PROPOSALS\2013\201305cu\Rp001_201305cu kob130705 SECURA opinion.docx

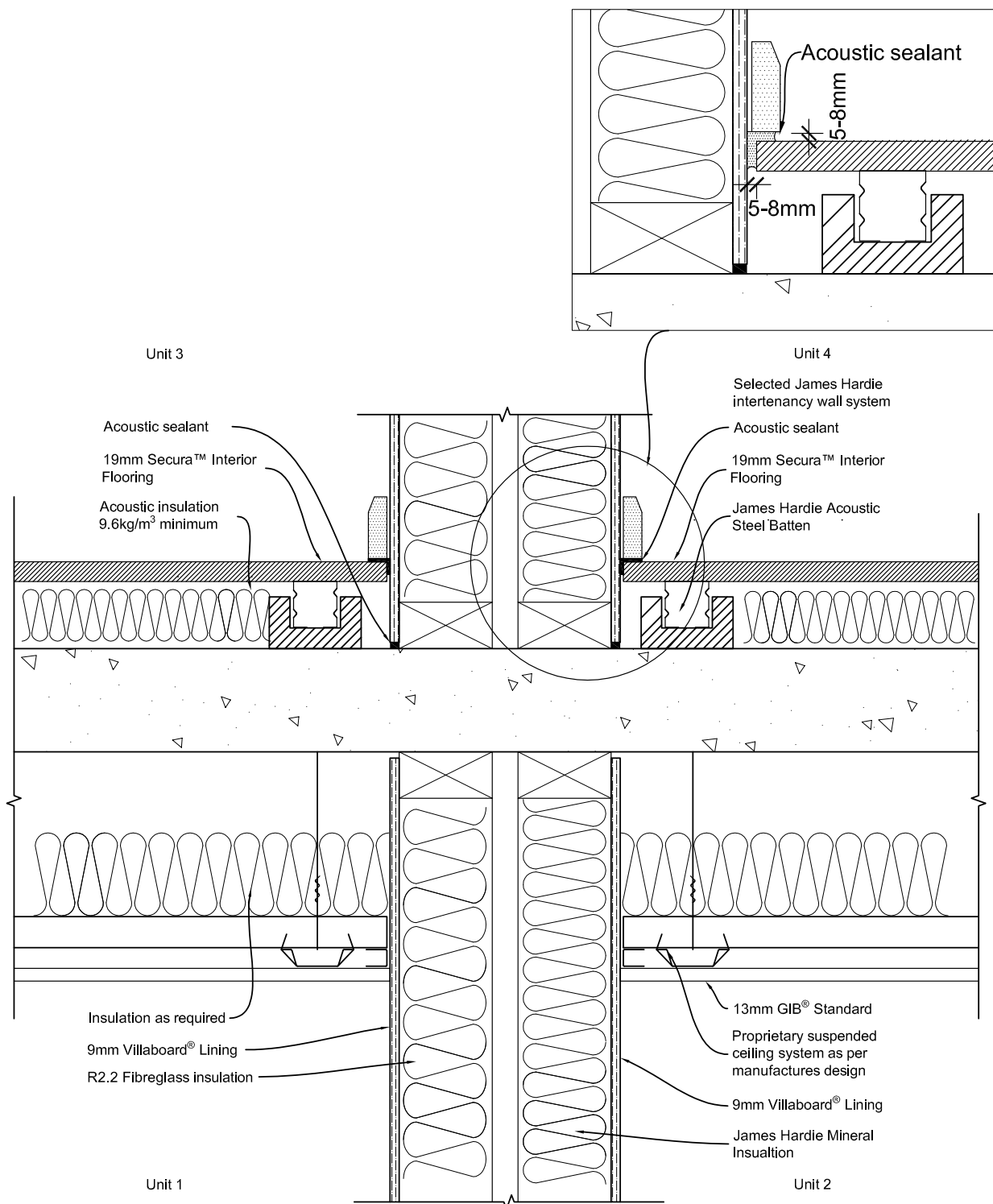

Notes:

1. Intertennancy walls must be full height to the underside of the slab.
2. Fire rating as per SED.
3. Concrete slab as per SED.
4. GIB® Quiet Tie® must be installed every 3rd stud (1.8m) along the length of wall to top plate.
5. Bottom plate to floor joist fixed as per NZS 3604 or SED

STC/IIC

1. STC=65
2. IIC=60

Note:

STC/IIC values are based on 100mm thick concrete.

Key Elevation

Unit 3	Unit 4
Unit 1	Unit 2

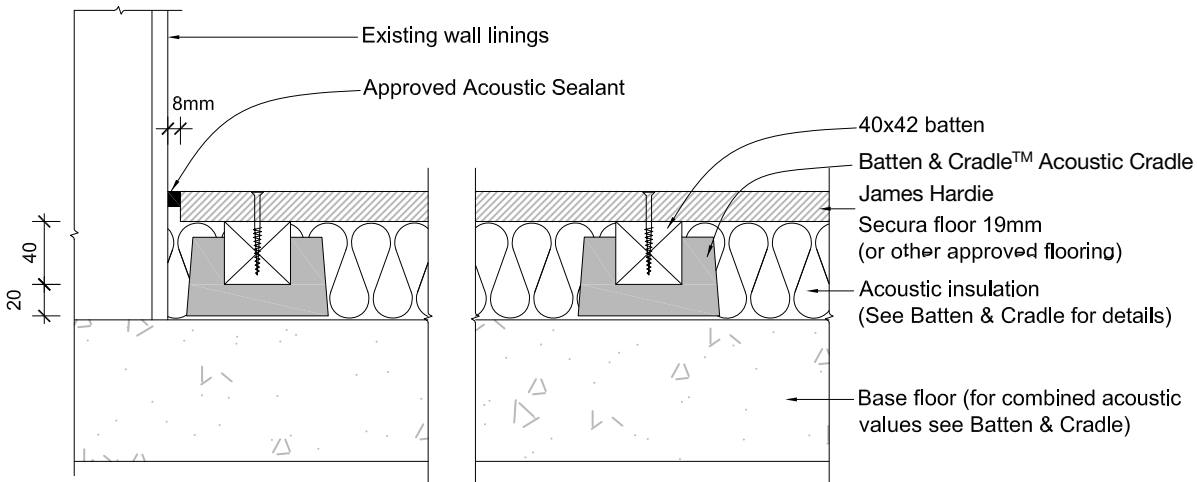

EDGE DETAIL

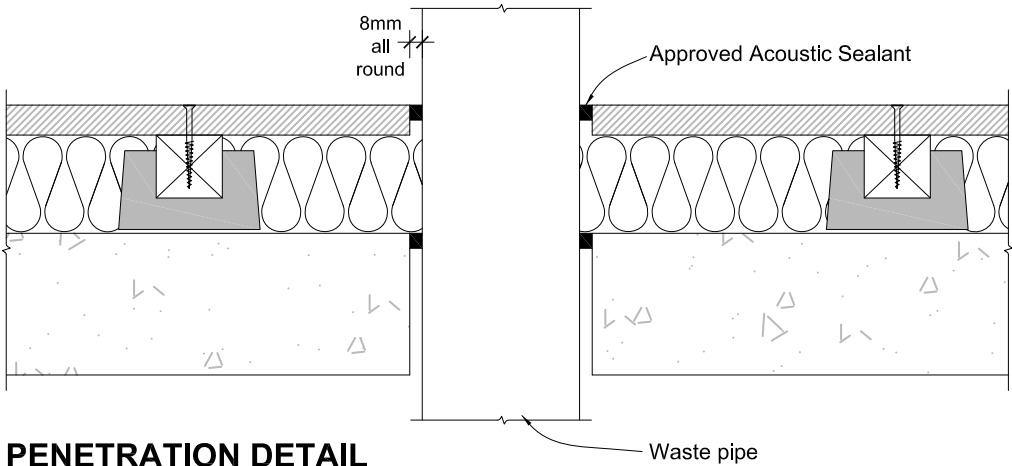

PENETRATION DETAIL

Note:
 All penetrations must be approved by a Registered Acoustic Engineer, to either eliminate, mitigate or manage acoustic layout that could lead to a degradation of the acoustic ability of the system

Any service penetration and detailing must be pre-approved by Batten & Cradle™.

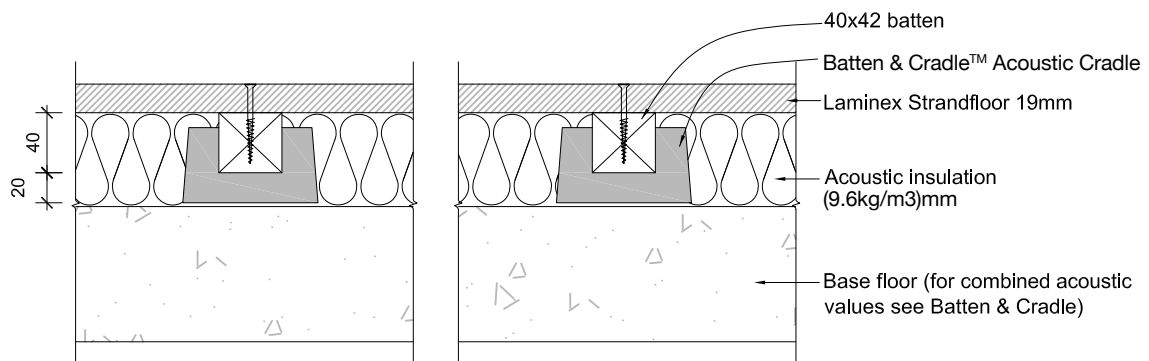

Note:

- Batten & Cradle™ Acoustic Cradle
- Acoustic Insulation
- Laminex Strandfloor 19mm (or other approved flooring)

Standard wooden battens available - 40mm
Other sizes available on request

Concrete Floor Overlay

Install Batten & Cradle™ Flooring System over concrete floors as per Strandfloor® second layer installation details in section 6.1.

The concrete overlay systems have various values dependent on floor and slab combinations refer to table:

Floor											
Ceiling		120 mm Hibond (average concrete thickness 90 mm)		75 mm Unispan + 75 mm topping		200 mm Dycore with 65 mm topping		120 mm Stahlton Rib and Infill (minimum concrete thickness 135 mm on 25 mm timber infills)		90 mm Interspan (minimum concrete thickness 90 mm on 25 mm timber infills)	
Thickness/ layers	Cavity Insulation Present?	Impact Insulation Class	L' _{nt,w} (+C ₁) (See Note 1)	Impact Insulation Class	L' _{nt,w} (+C ₁) (See Note 1)	Impact Insulation Class	L' _{nt,w} (+C ₁) (See Note 1)	Impact Insulation Class	L' _{nt,w} (+C ₁) (See Note 1)	Impact Insulation Class	L' _{nt,w} (+C ₁) (See Note 1)
No plasterboard ceiling	N/A	IIC 57	53 (+0) dB	IIC 64	46 (+1) dB	IIC 65	45 (+0) dB	IIC 62	48 (+0) dB	IIC 58	52 (+0) dB
1 x 10 mm plasterboard	No	IIC 54	53 (+1) dB	IIC 59	45(+3) dB	IIC 60	44 (+3) dB	IIC 58	48 (+1) dB	IIC 55	52 (+1) dB
	Yes	IIC 63	42 (+2) dB	IIC 66	37(+4) dB	IIC 67	36 (+4) dB	IIC 67	39 (+2) dB	IIC 64	41 (+2) dB
1 x 13 mm plasterboard	No	IIC 58	48 (+2) dB	IIC 63	40 (+3) dB	IIC 64	40 (+3) dB	IIC 62	43 (+2) dB	IIC 59	47 (+2) dB
	Yes	IIC 74	34 (+1) dB	IIC 77	28(+2) dB	IIC 78	27 (+2) dB	IIC 78	30 (+1) dB	IIC 75	33 (+1) dB
2 x 13 mm plasterboard	No	IIC 62	43 (+3) dB	IIC 67	36(+4) dB	IIC 68	35 (+4) dB	IIC 65	39 (+2) dB	IIC 63	42 (+3) dB
	Yes	IIC 78	32 (+0) dB	IIC 81	26(+1) dB	IIC 82	24 (+2) dB	IIC 82	28 (+0) dB	IIC 79	31 (+0) dB

Figure 8 Concrete Mid Floor

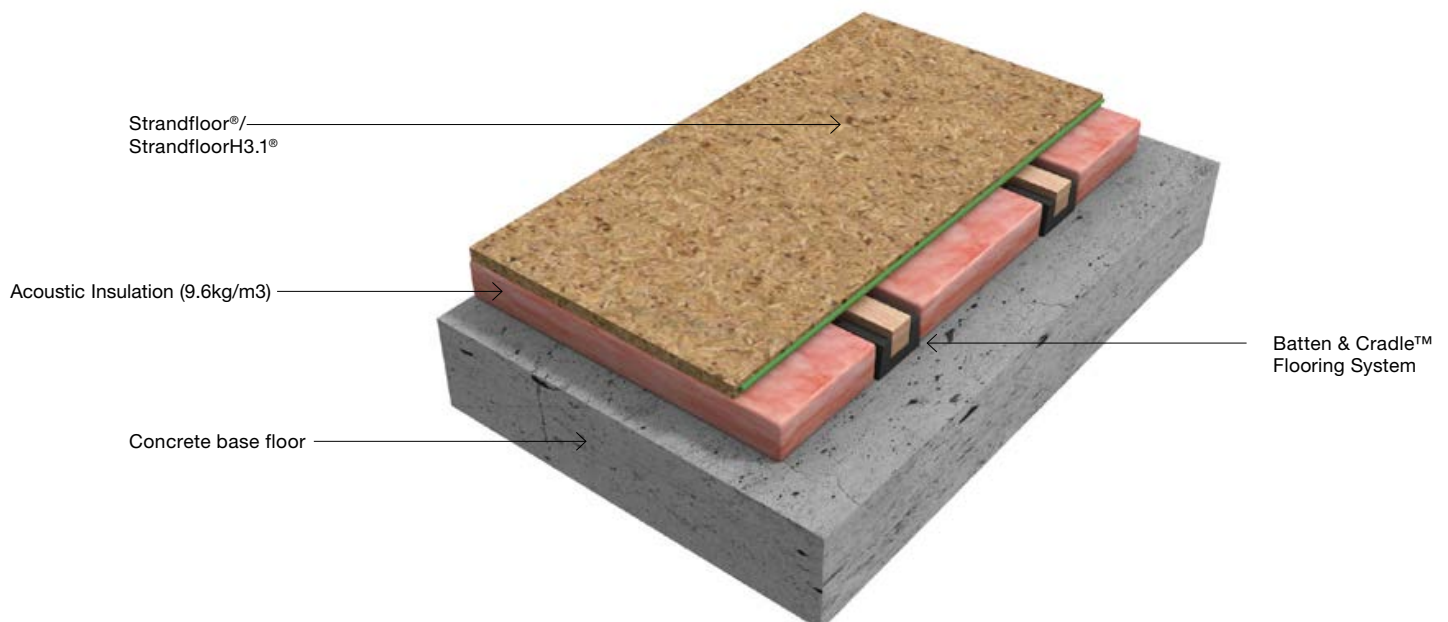

Figure 9 Concrete Mid Floor detail

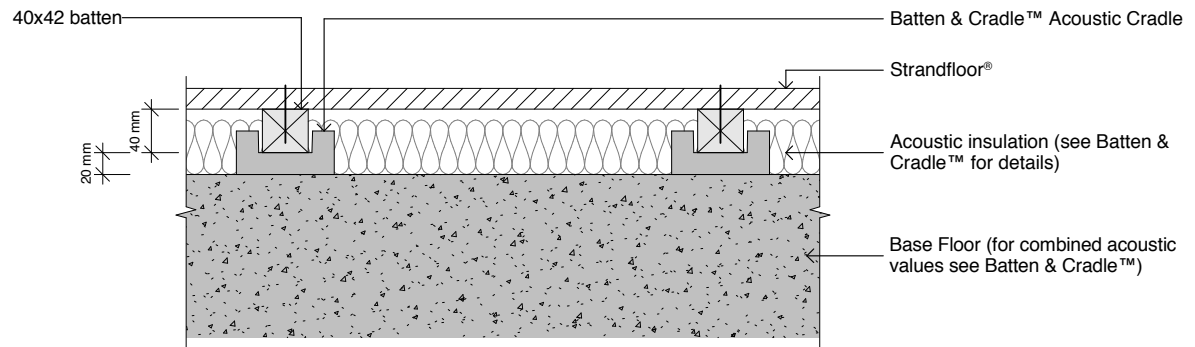

Figure 10

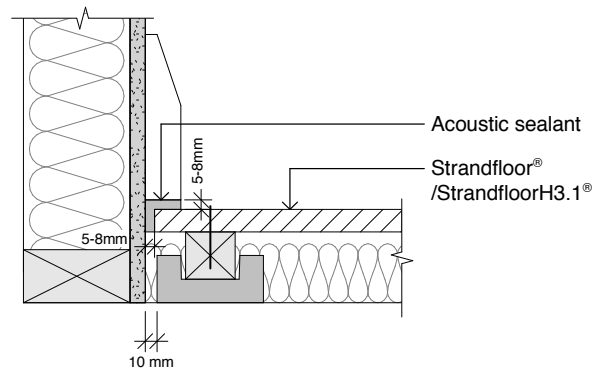
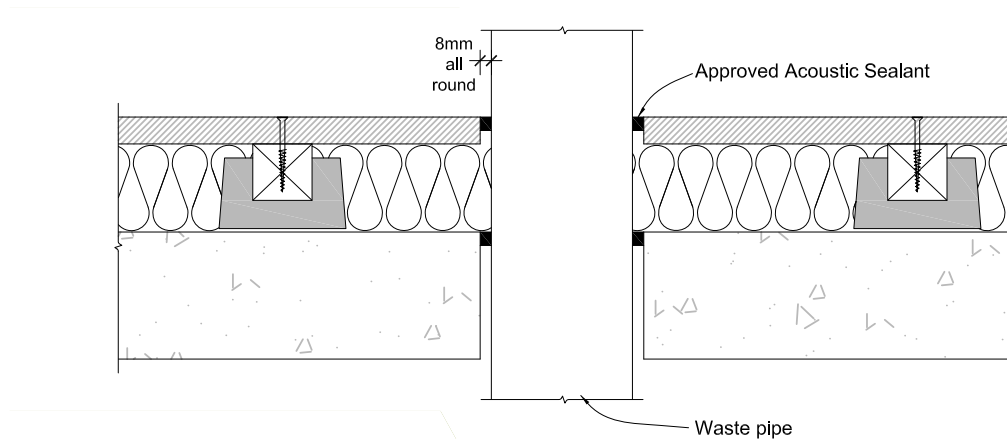
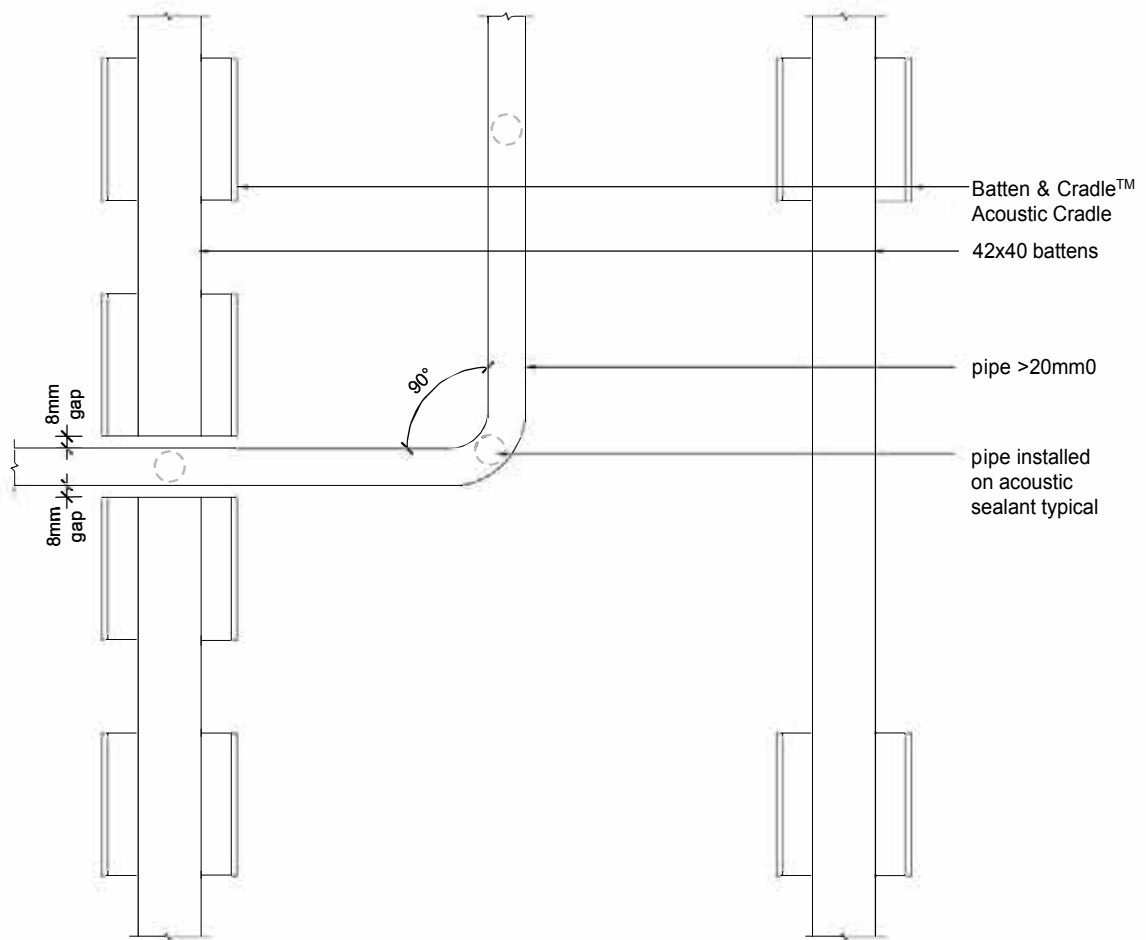

Figure 10a



NOTE:

All penetrations must be approved by a Registered Acoustic Engineer, to either eliminate, mitigate or manage acoustic layout that could lead to a degradation of the acoustic ability to the system.



PIPE >20mmØ - PLAN VIEW

Note:
Representative Example of Structural Detail
Please refer to Batten & Cradle "Acoustiflor"™ Technical Department for any further options needed

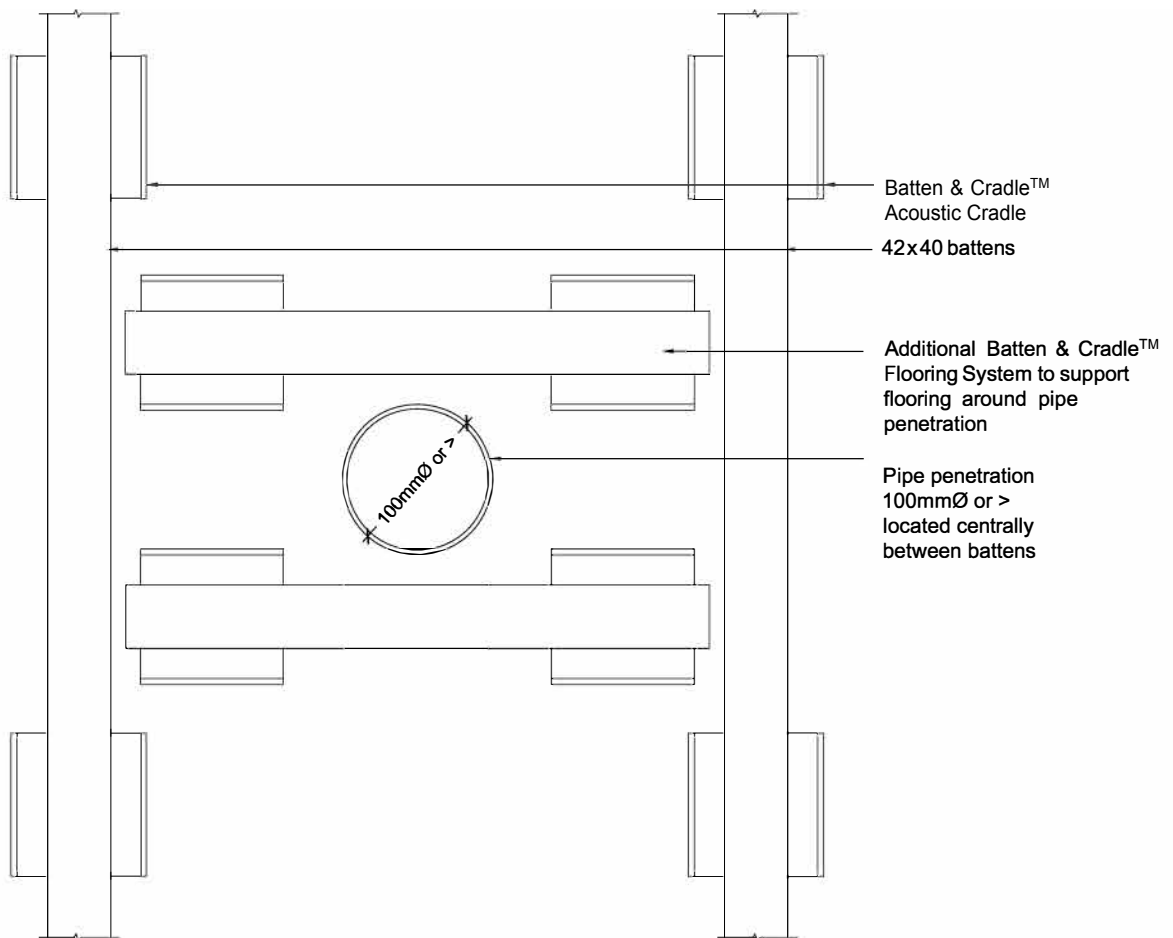

PIPE PENETRATION >100mmØ LOCATED CENTRALLY - PLAN VIEW

Note:
Representative Example of Structural Detail
Please refer to Batten & Cradle "Acoustiflor"™ Technical Department for any further options needed

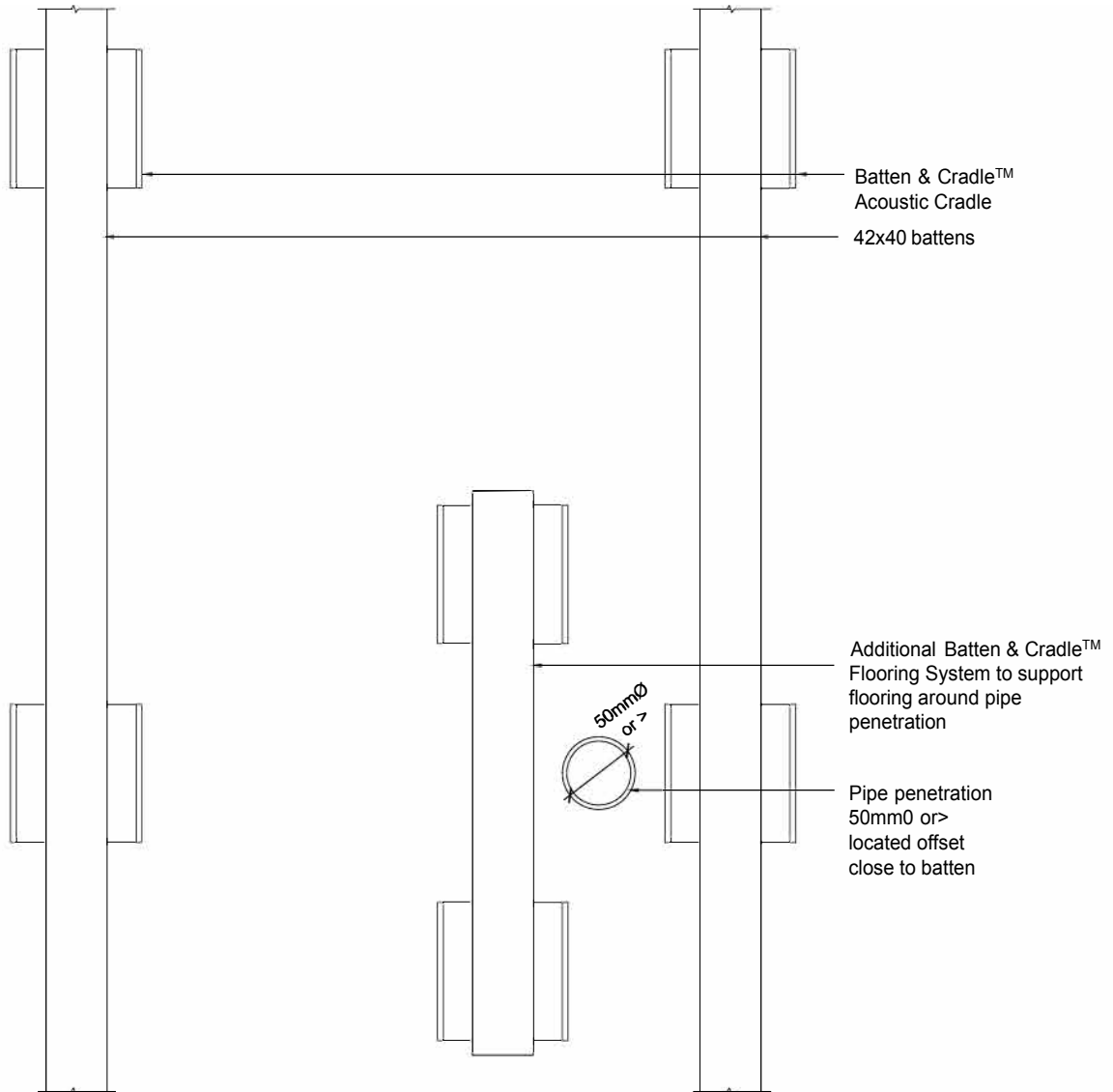

PIPE PENETRATION >50mmØ LOCATED OFFSET NEAR BATTEN - PLAN VIEW

Note:
Representative Example of Structural Detail
Please refer to Batten & Cradle™ Flooring System Technical Department for any further options needed



Fire and Acoustic



Design Manual

When specifying or installing James Hardie products, ensure you have the current manual. If you're not sure you do, or you need more information, visit www.jameshardie.co.nz or Ask James Hardie™ on 0800 808 868.

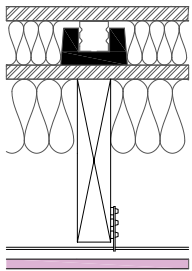
JHFTGS _d 60	Fire Resistance Rating	STC / IIC	Floor/Lining option
	60	62/58	Secura™ Interior Flooring with 2 x 13mm GIB Fyreline® Additional layer of Secura™ Interior Flooring to James Hardie Acoustic Floor Channel and James Hardie Acoustic Cradle
			

TWO WAY 60 MINUTE – TIMBER FRAMED FLOOR

FRAMING

Floor joists to be in accordance with NZS 3604 or alternatively, solid timber joist, Hyspan® and Hyjoist® series joists can also be used in accordance with a specific engineering design meeting the requirements of AS/NZS 1170.

Floor joist depth to be 200mm minimum provide at 450mm c/c maximum spacing.

Solid blocking for floor/ceiling to wall junctions to be in accordance with NZS 3604 or as per floor joist manufacturer.

Nogs/framing is required at the perimeter of fire rated ceiling to facilitate GIB Fyreline® fixing.

Timber framing treatment to be in accordance with the NZBC Acceptable Solution B2/AS1.

Note: Posi-Strut® floor joists are not suitable for this system.

FLOOR

Secura Interior Flooring 2700 x 600 x 19mm.

FIXING/JOINTING

Secura Interior Flooring fixed as per its installation manual. Flooring edges other than tongue and groove must be supported over floor joists.

INSULATION

Acoustic insulation between timber joists. Minimum 9.6kg/m³.

FLOATING FLOOR

Secura Interior Flooring 2700 x 600 x 19mm fixed to James Hardie Acoustic Floor Channel spacing at 450mm maximum centres. Flooring edges other than tongue and groove must be supported over floor channel. Floating Secura Flooring to butt into external/internal walls allowing a gap of 5-8mm. Fill the gap with flexible acoustic sealant.

RUBBER CRADLE

James Hardie Acoustic Rubber Cradle spaced at 450mm maximum centres along the batten.

INSULATION

Acoustic insulation between acoustic floor channel. Minimum 9.6kg/m³.

CEILING LINING

2 x 13mm GIB Fyreline® installed at right angles as specified below to the underside of GIB Quiet Clip® and GIB® Rondo® Metal Ceiling Battens.

FIXING

- Secura Interior Flooring to be fixed with self tapping steel screws at 200mm centre around the sheet perimeter and intermediate joists/battens.
- Flooring Fixings to be 12mm from sheet ends and 25mm from t&g sheet joints.

INNER LAYER

- 13mm GIB Fyreline® fixed with 25mm x 6g GIB® Grabber® Drywall Self Tapping Screws.

OUTER LAYER

- Fixed with 41mm x 6g screws
- Fyreline® Fixings to be 12mm from board sheet edges and 18mm from sheet end.
- Refer to GIB Fire & Noise system manual for further information.

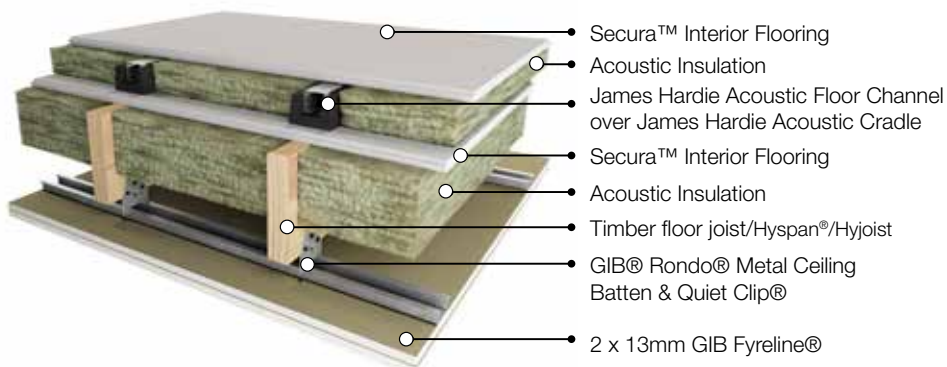

For further information refer to the clauses in the Fire and Acoustic Design Manual.

Figure 11: Timber Floor to Floor Intertency Wall Junction

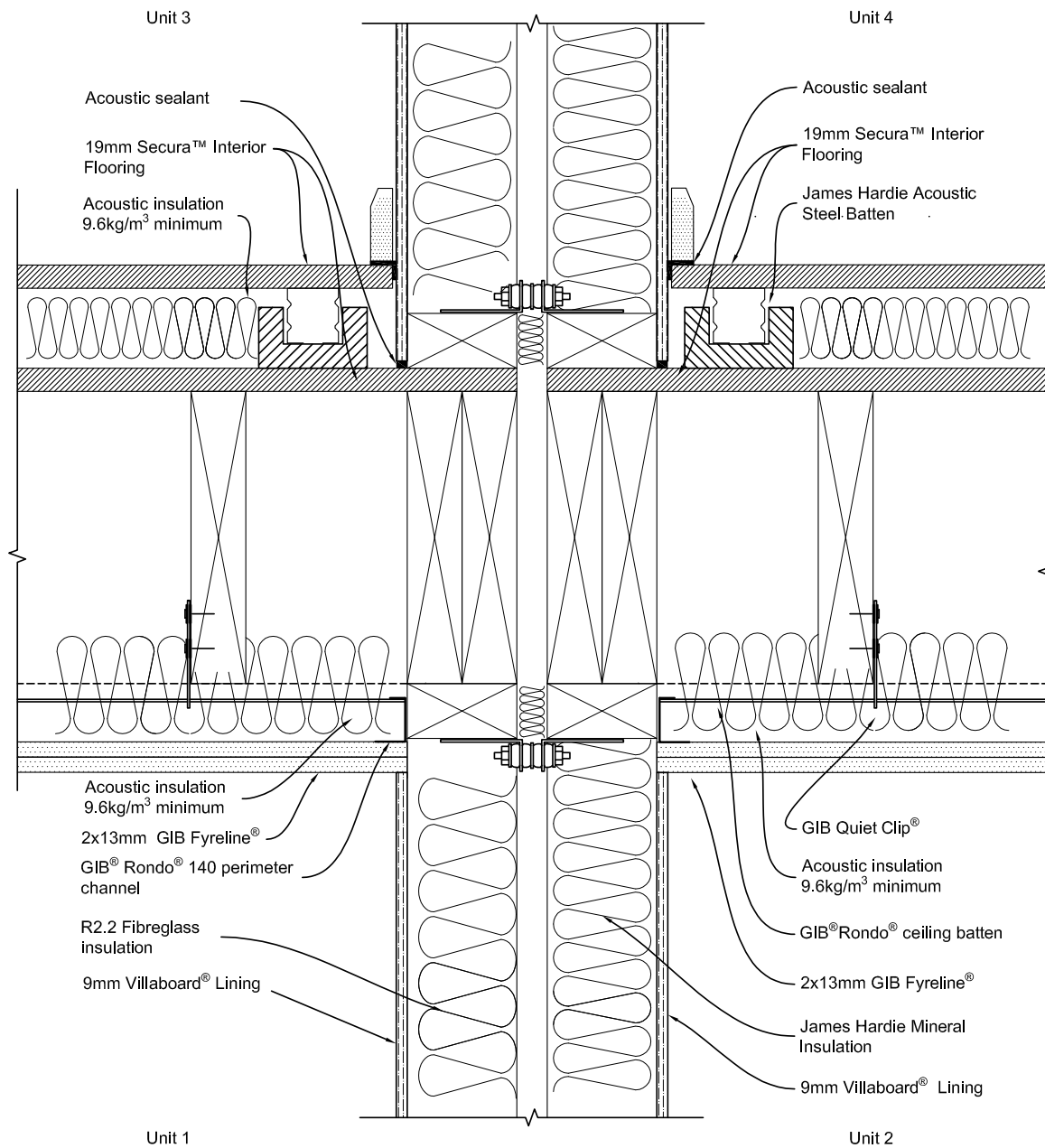

Notes:

For joist framing at 90° to intertenancy wall, solid blocking must be used between joists under.

GIB® Quiet Tie® must be installed every 3rd stud (1.8m) along the length of wall to bottom plate and top plate.

Bottom plate to floor joist fixed as per NZS 3604 or SED

Key Elevation

Unit 3	Unit 4
Unit 1	Unit 2

Figure 12: Split Level Floor to Intertency Wall Junction

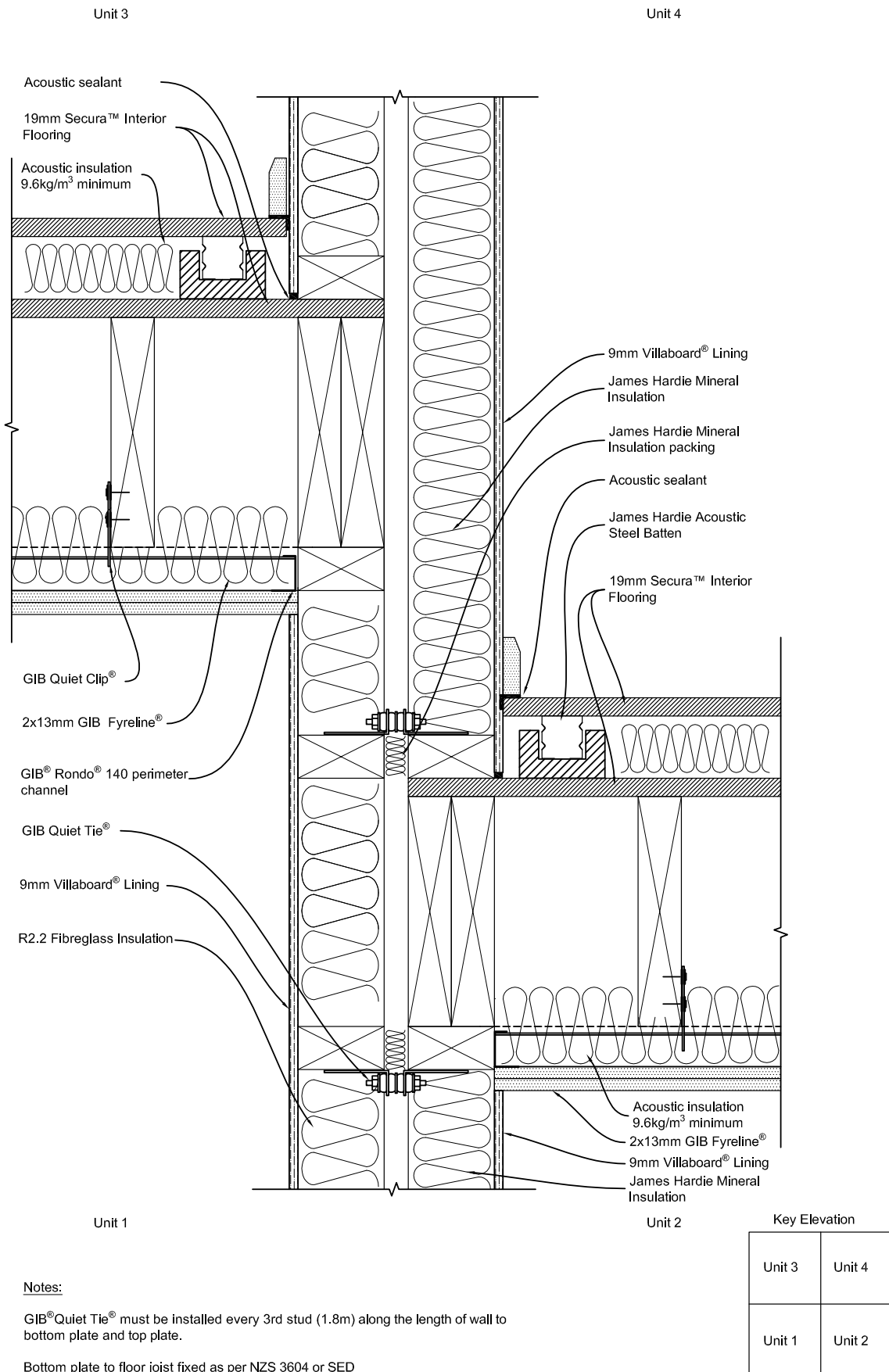
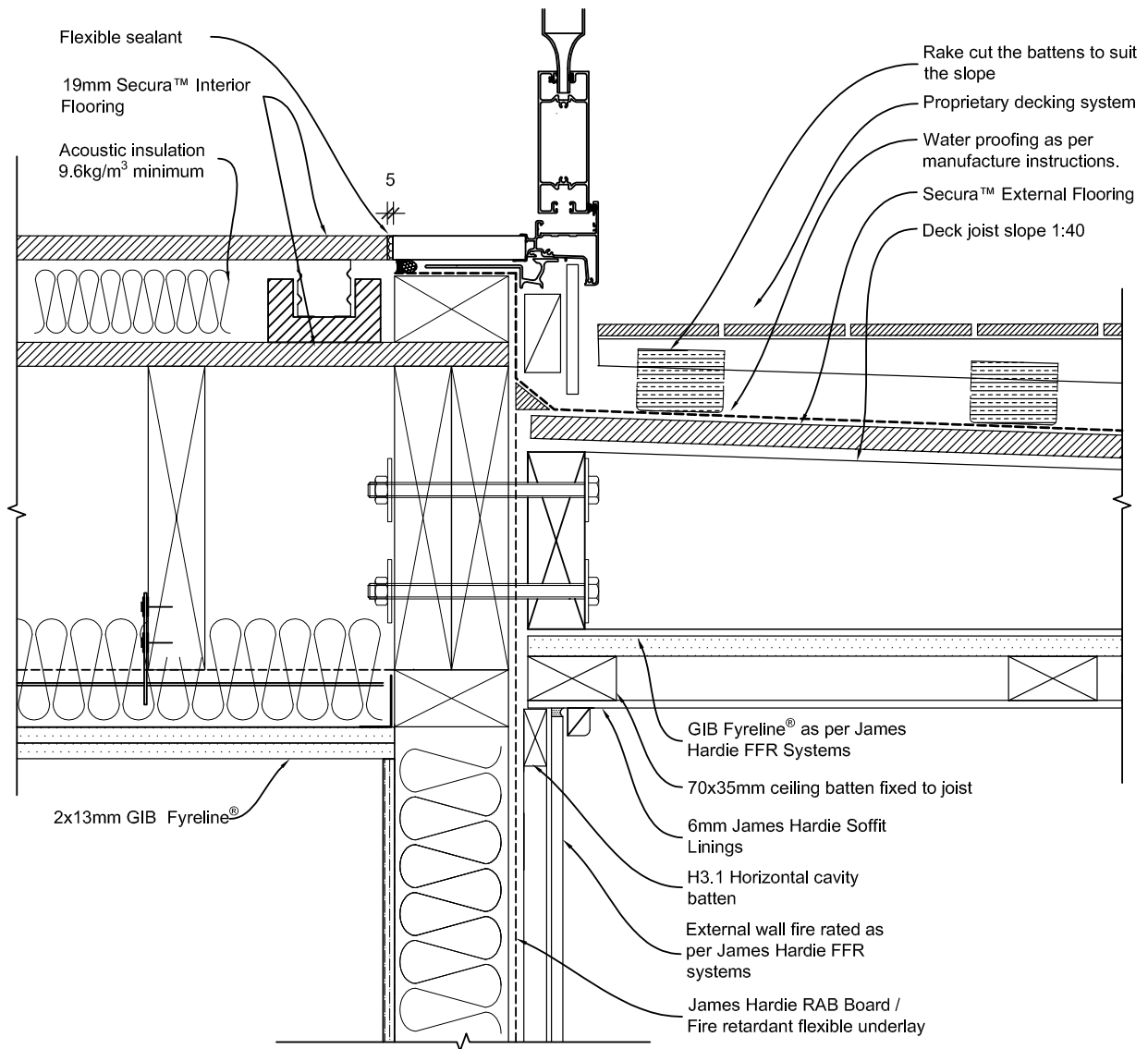
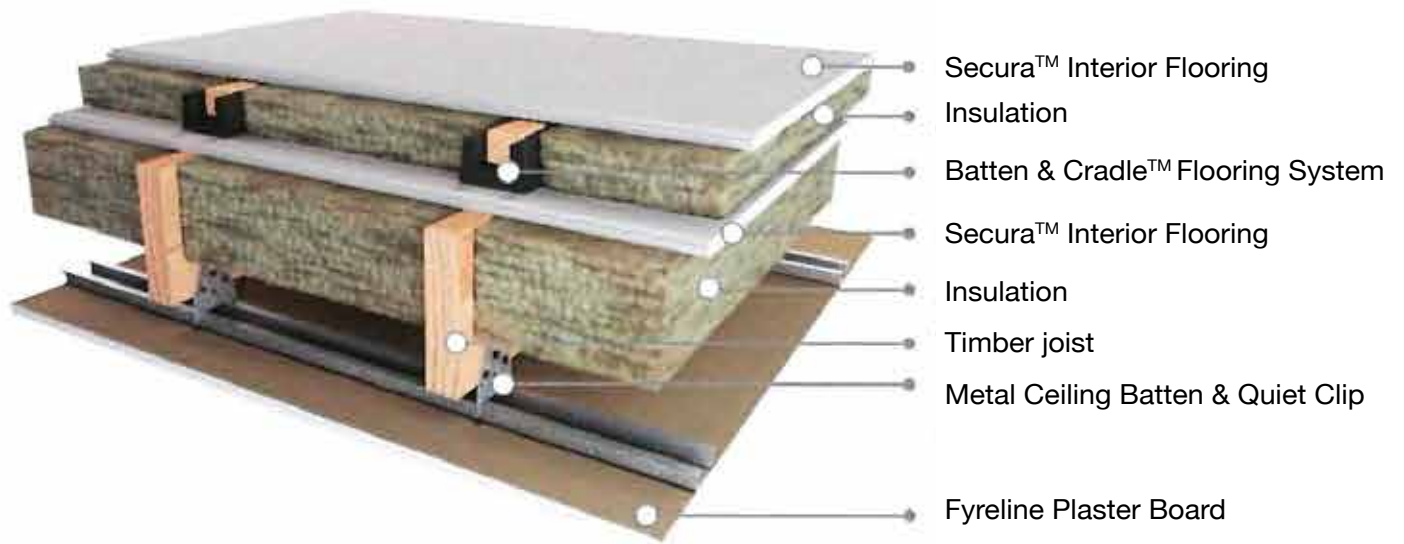

Figure 13: Floor to Deck Junction



Note:
 1) Deck structure as per NZS3604 or SED.

James Hardie
SECURA™ INTERIOR FLOOR
FRR60 ACOUSTIC SYSTEM



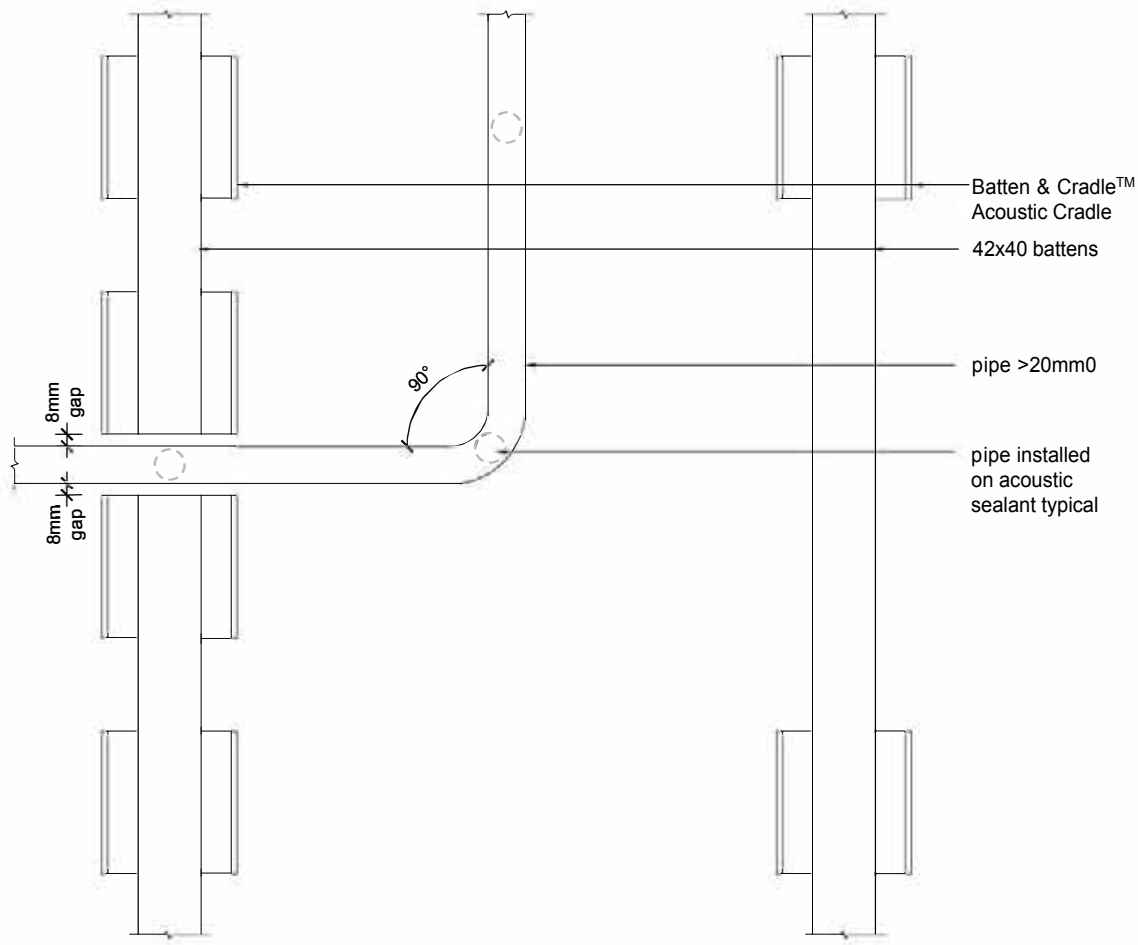

PIPE >20mmØ - PLAN VIEW

Note:
 Representative Example of Structural Detail
 Please refer to Batten & Cradle "Acoustiflor"™ Technical Department for any further options needed

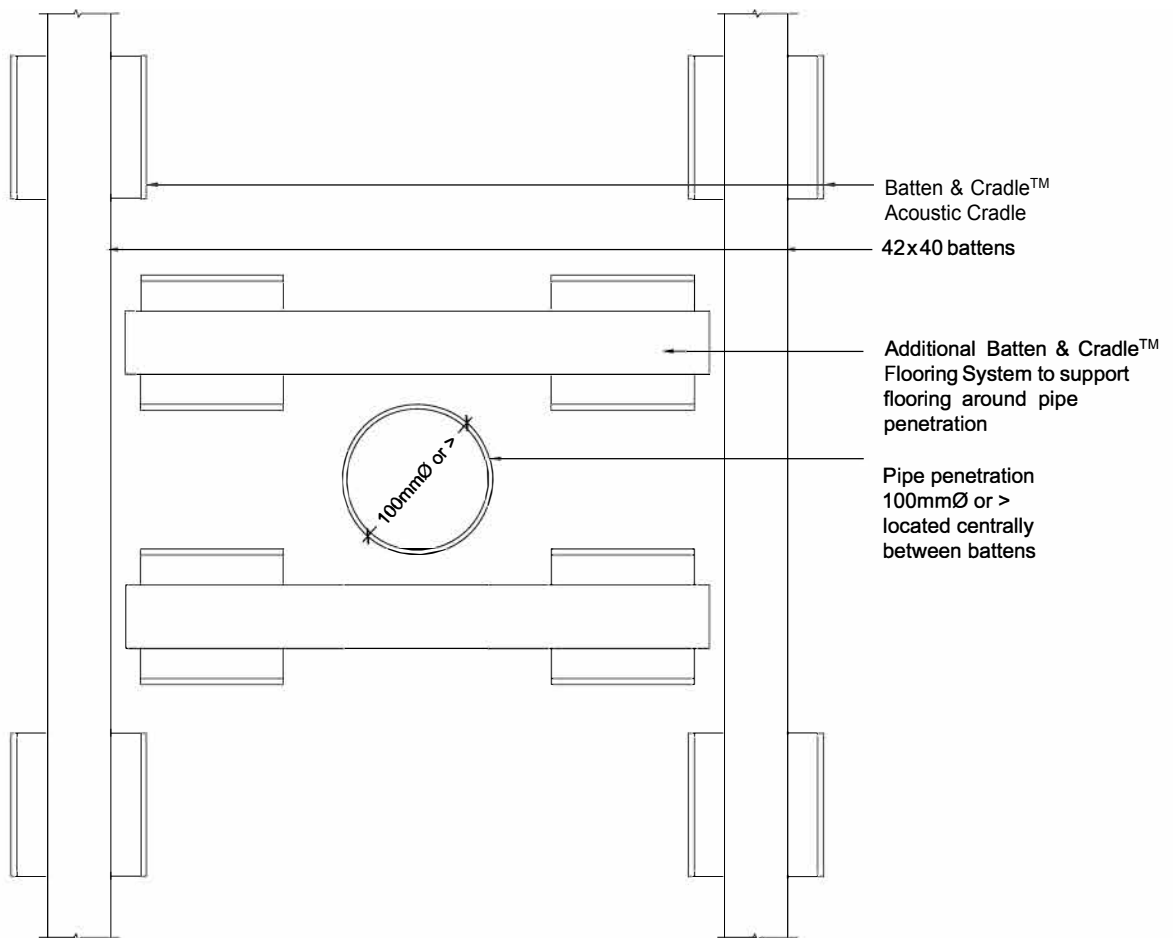

PIPE PENETRATION >100mmØ LOCATED CENTRALLY - PLAN VIEW

Note:
Representative Example of Structural Detail
Please refer to Batten & Cradle "Acoustiflor"™ Technical Department for any further options needed

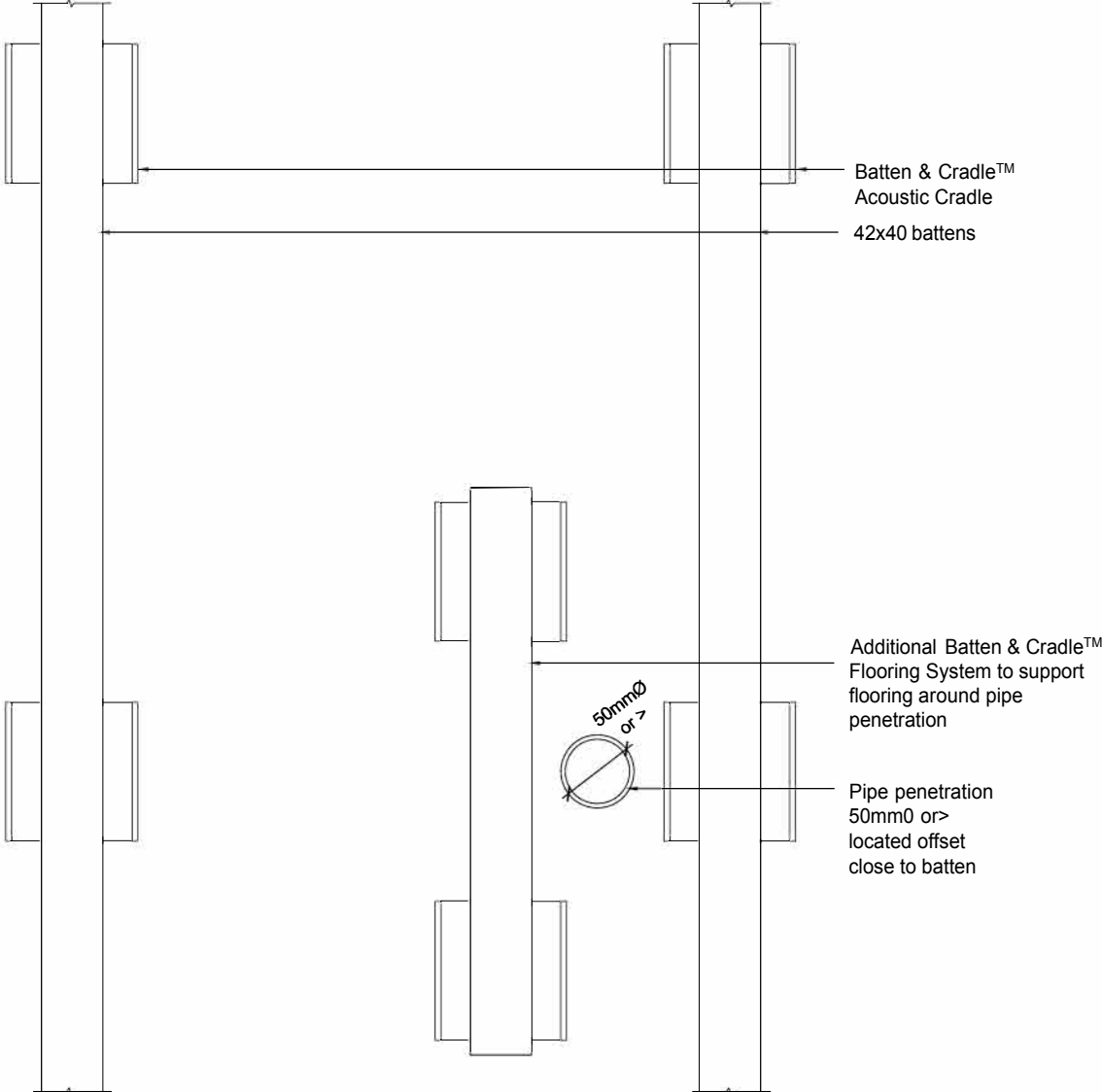

PIPE PENETRATION >50mmØ LOCATED OFFSET NEAR BATTEN - PLAN VIEW

Note:
Representative Example of Structural Detail
Please refer to Batten & Cradle™ Flooring System Technical Department for any further options needed



Noise Control Systems

Specification and installation manual

This publication may be superseded by a new publication. Winstone Wallboards accepts no liability for reliance upon publications that have been superseded. You should check the website, www.gib.co.nz, to ensure you are using the current publication. If you are unsure whether this is the current publication, simply call the GIB® Helpline on 0800 100 442.

CBI5113

SEPTEMBER 2017

Floor/ceiling — timber joists

Specification number	Performance	Specifications
GBDFA 60d	STC 67 Rw 65 FRR 60/60/60	Lining 2 x 13mm GIB Fyreline® LB/NLB Load bearing IIC* 57–76

FLOOR FRAMING

Floor joists shall comply with NZS 3604, be spaced at 450mm centres maximum and have a depth of 190mm minimum.

ALTERNATIVE FLOOR FRAMING

Use either Hyspan® or Hybeam® HJ series joists designed for serviceability, no less than 200mm deep and spaced at no more than 450mm. Consult the joist manufacturer regarding construction of the solid blocking contained in the floor/ceiling to wall junctions.

FLOORING

James Hardie Secura Interior Flooring fixed at right angles to the timber floor joists. Sheet edges other than tongue and groove must be supported by floor joists. Sheets must be laid in a staggered pattern. The minimum length for a cut sheet is 900mm. Apply a 6mm continuous bead of adhesive to joists prior to installation of sheets.

FASTENING THE FLOORING

Adhesive

- Bostik Seal 'n' Flex 1; or,
- Sika Sikaflex 11FC; or,
- Holdfast 220LM.

Fasteners

- 40mm x 10g wood thread self embedding screws; or,
- 50 x 2.87mm stainless steel ring RounDrive nails; or,
- 50 x 2.87mm Dekfast HD galvanised RounDrive nails.

Fastener Centres (both layers)

200mm centres along each joist. Place fasteners no closer than 25mm to longitudinal sheet edges and 12mm from transverse sheet edges. Place fasteners no closer than 50mm to sheet corners.

FLOATING FLOOR AND FLOORING VOID SOUND CONTROL INFILL

Space the James Hardie Acoustic Cradles at 450mm maximum centres on the bottom layer of James Hardie Secura Interior Flooring. The James Hardie Acoustic Cradles do not need to be aligned with the timber floor joists and are not to be fixed down to the bottom layer of James Hardie Secura Interior Flooring.

Place the James Hardie Acoustic Channels in the James Hardie Acoustic Cradles. Space James Hardie Acoustic Channels at 450mm maximum centres.

Place 50mm thick sound control infill between James Hardie Acoustic Channels. Minimum density 9.6 kg/m³. A suitable product is Pink® Batts® R1.2 (50mm) glass wool insulation.

James Hardie Secura Interior Flooring fixed at right angles to the James Hardie Acoustic Channels. Sheet edges other than tongue and groove must be supported by channels. Sheets must be laid in a staggered pattern. The minimum length for a cut sheet is 900mm. Ensure the sheets are laid the correct way down depending on the final finish i.e. tiles or vinyl. Apply a 6mm continuous bead of adhesive to joists prior to installation of sheets.

Allow a 5mm minimum gap where sheet edges butt into external/internal walls. Fill gap with GIB Soundseal® acoustic sealant.

In designated wet areas there is a need to seal the sheet joints and apply a waterproof membrane. If tiles are to be applied as a final finish there may be a requirement to form one or more control joints.

GIB QUIET CLIP® AND BATTENS

The GIB Quiet Clip® shall be fastened to the joists at maximum 1200mm centres (and no less than 900mm centres) to support the GIB® Rondo® metal ceiling battens.

INSTALLING THE GIB QUIET CLIP®

Use 3 x 32mm x 8g GIB® Grabber® Self Tapping Wafer Head Screws. Insert the first screw into the middle rubber grommet, tighten enough to hold the GIB Quiet Clip® in place, adjust the clip to the correct height, insert the remaining two screws and tighten. Do not overtighten the screws to the point where the grommet is crushed. The screws should be tightened enough to allow the flexibility to remain in the connection between the grommet and the timber joists.

CEILING VOID SOUND CONTROL INFILL

Place minimum 75mm thick sound control infill on top of the GIB® Rondo® metal ceiling battens. Minimum density 9.6 kg/m³. A suitable product is Pink® Batts® BIB R1.8 (75mm) glass wool insulation.

CEILING LINING

2 layers of 13mm GIB Fyreline® fixed at right angles to the steel battens.

Offset the joints of the outer layer by 600mm from those of the inner layer. All sheet end butt joints shall occur on the battens and are offset between the first and second layers. Sheet joints are touch fitted.

FASTENING THE LINING

Fasteners

Inner layer: 32mm x 6g GIB® Grabber® Self Tapping Drywall Screws.

Outer layer: 41mm x 6g GIB® Grabber® Self Tapping Drywall Screws.

Fastener centres (both layers)

200mm centres along each batten and at 100mm centres along sheet end butt joints. Place fasteners no closer than 12mm to the sheet edges.

ACOUSTIC SEALANT

A bead of GIB Soundseal® acoustic sealant is required around the ceiling perimeter.

WALL/CEILING JUNCTIONS

The internal angle between ceiling and walls must be protected by GIB-Cove® adhered with GIB-Cove® Bond, or boxed corners (square stopped) filled and taped in accordance with the publication entitled GIB® Site Guide.

Floor/ceiling — timber joists

Specification number	Performance	Specifications
GBDFA 60d	STC 67 Rw 65 FRR 60/60/60	Lining 2 x 13mm GIB Fyreline® LB/NLB Load bearing IIC* 57–76

JOINTING

All fastener heads stopped and all sheet joints tape reinforced and stopped in accordance with the publication entitled GIB® Site Guide.

SUPPLEMENTARY MATERIAL

For additional information covering general and wet area installations of James Hardie Secura Interior Flooring, refer to the James Hardie Secura Interior Flooring Installation Manual.

*Impact Insulation Class (IIC)

A performance of IIC 57 is achieved with a bare floor.

A performance of IIC 57 is achieved with a floor covering of 4mm cushion-backed vinyl.

A performance of IIC 76 is achieved with a floor covering of 40oz cut pile carpet loose laid on 8mm foam underlay.

Note: See page 90 for perimeter details.

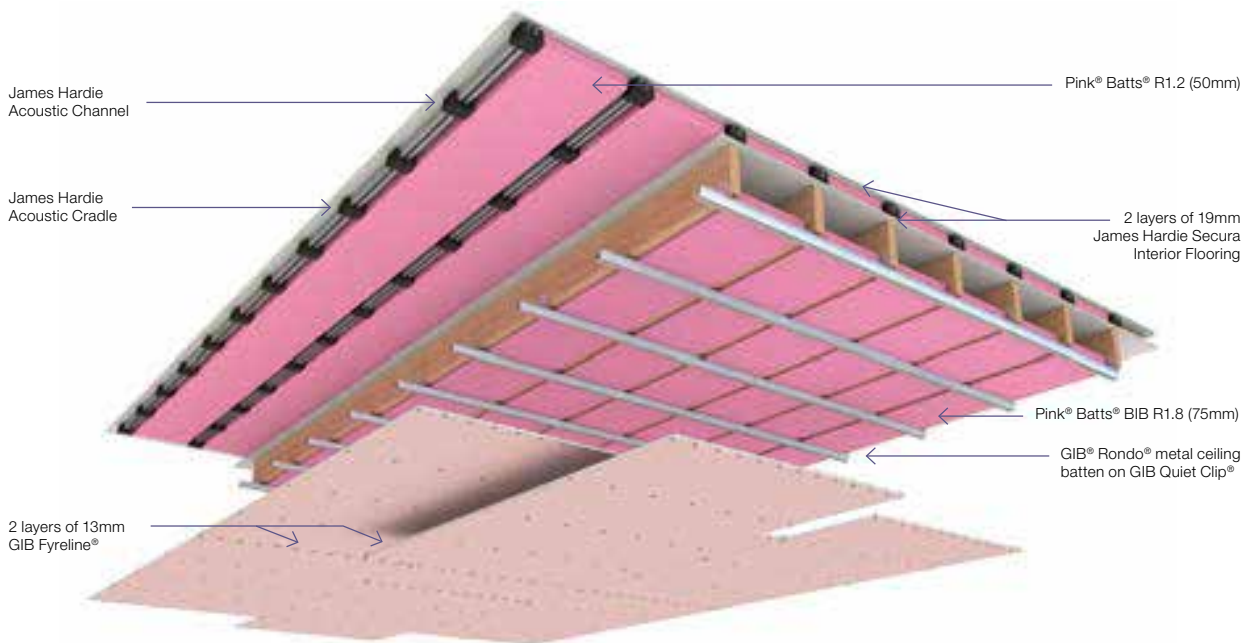

CONSTRUCTION DETAIL

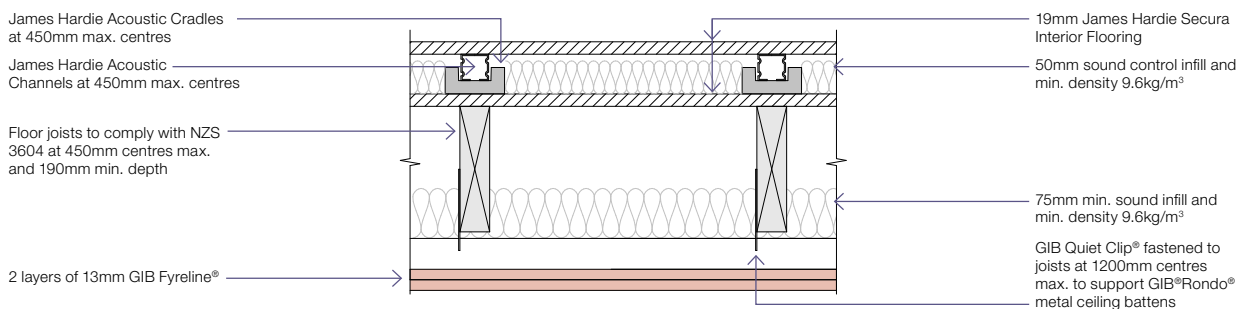

GNS020

Floor/ceiling – timber joists

Specification number	Performance	Specifications
GBDFA 60e	STC 65 Rw 64 FRR 60/60/60	Lining 2 x 13mm GIB Fyreline® LB/NLB Load bearing IIC* 56–72

FLOOR FRAMING

Floor joists shall comply with NZS 3604, be spaced at 600mm centres maximum and have a depth of 190mm minimum.

ALTERNATIVE FLOOR FRAMING

Use either Hyspan® or Hybeam® HJ series joists designed for serviceability, no less than 190mm deep and spaced at no more than 600mm. Consult the joist manufacturer regarding construction of the solid blocking contained in the floor/ceiling to wall junctions.

FLOORING

Laminex Strandfloor® Tongue & Groove or Laminex Strandfloor® H3.1 Tongue & Groove flooring fixed at right angles to the floor joists. Sheet edges other than tongue and groove must be supported by floor joists. No nogging required to support longitudinal sheet joints. Sheets must be laid in a staggered pattern. The minimum length for a cut sheet is 900mm. Apply a 6mm continuous bead of adhesive to joists prior to installation of sheets.

FASTENING THE FLOORING

Adhesive is recommended for use in conjunction with mechanical fastening on both layers.

Adhesive

- Bostik – Alpha Grip; or,
- Sika – Nailbond Premium; or,
- Holdfast – Gorilla Grip; or,
- HB Fuller – Sturdi Bond.

Adhesive shall be applied in a continuous 5mm bead to all floor joists and between sheet ends. A 2mm bead shall be applied along the tongue of the tongue & groove panels as they are laid.

Fasteners

45mm x 8g wood thread self drilling screws (corrosion resistant).

Fastener Centres (both layers)

200m centres along each joist. Place fasteners no closer than 15mm to longitudinal and transverse sheet edges. Place fasteners no closer than 50mm to sheet corners.

FLOATING FLOOR AND FLOORING VOID SOUND CONTROL INFILL

Space AcoustiFlor™ Acoustic Cradles at 450mm maximum centres on the bottom layer of Laminex Strandfloor® Tongue & Groove flooring. The AcoustiFlor™ Acoustic Cradles do not need to be aligned with the timber floor joists and are not to be fixed down to the bottom layer of Laminex Strandfloor® Tongue & Groove flooring.

Place the Acoustiflor™ Structural Battens in the AcoustiFlor™ Acoustic Cradles. Space AcoustiFlor™ Structural Battens at 400mm maximum centres.

Place 50mm thick sound control infill between Acoustiflor™ Structural Battens. Minimum density 9.6 kg/m³. A suitable product is Pink® Batts® R1.2 (50mm) glass wool insulation.

Laminex Strandfloor® Tongue & Groove flooring, fixed at right angles to the Acoustiflor™ Structural Battens. Sheet edges other than tongue and groove must be supported by battens. Sheets must be laid in a staggered pattern. The minimum length for a cut sheet is 900mm. Ensure the sheets are laid the correct way down depending on the final finish i.e. tiles or vinyl. Apply a 6mm continuous bead of adhesive to joists prior to installation of sheets.

Allow a 5mm minimum gap where sheet edges butt into external/internal walls. Fill gap with GIB Soundseal® acoustic sealant.

In designated wet areas there is a need to seal the sheet joints and apply a waterproof membrane. If tiles are to be applied as a final finish there may be a requirement to form one or more control joints.

GIB QUIET CLIP® AND BATTENS

The GIB Quiet Clip® shall be fastened to the joists at maximum 1200mm centres (and no less than 900mm centres) to support the GIB® Rondo® metal ceiling battens.

INSTALLING THE GIB QUIET CLIP®

Use 3 x 32mm x 8g GIB® Grabber® Self Tapping Wafer Head Screws. Insert the first screw into the middle rubber grommet, tighten enough to hold the GIB Quiet Clip® in place, adjust the clip to the correct height, insert the remaining two screws and tighten. Do not overtighten the screws to the point where the grommet is crushed. The screws should be tightened enough to allow the flexibility to remain in the connection between the grommet and the timber joists.

CEILING VOID SOUND CONTROL INFILL

Place minimum 75mm thick sound control infill on top of the GIB® Rondo® metal ceiling battens. Minimum density 9.6 kg/m³. A suitable product is Pink® Batts® BIB R1.8 (75mm) glass wool insulation.

CEILING LINING

2 layers of 13mm GIB Fyreline® fixed at right angles to the steel battens.

Offset the joints of the outer layer by 600mm from those of the inner layer. All sheet end butt joints shall occur on the battens and are offset between the first and second layers. Sheet joints are touch fitted.

FASTENING THE LINING

Fasteners

Inner layer: 32mm x 6g GIB® Grabber® Self Tapping Drywall Screws.

Outer layer: 41mm x 6g GIB® Grabber® Self Tapping Drywall Screws.

Fastener centres (both layers)

200mm centres along each batten and at 100mm centres along sheet end butt joints. Place fasteners no closer than 12mm to the sheet edges.

Floor/ceiling — timber joists

Specification number	Performance	Specifications
GBDFA 60e	STC 65	Lining 2 x 13mm GIB Fyreline®
	Rw 64	LB/NLB Load bearing
	FRR 60/60/60	IIC* 56–72

ACOUSTIC SEALANT

A bead of GIB Soundseal® acoustic sealant is required around the ceiling perimeter.

WALL/CEILING JUNCTIONS

The internal angle between ceiling and walls must be protected by GIB-Cove® adhered with GIB-Cove® Bond, or boxed corners (square stopped) filled and taped in accordance with the publication entitled GIB® Site Guide.

JOINTING

All fastener heads stopped and all sheet joints tape reinforced and stopped in accordance with the publication entitled GIB® Site Guide.

SUPPLEMENTARY MATERIAL

For additional information covering general and wet area installations of Laminex Strandfloor® Tongue & Groove or Laminex Strandfloor® H3.1 Tongue & Groove flooring, refer to the Laminex Strandfloor® Technical Manual.

*Impact Insulation Class (IIC)

A performance of IIC 56 is achieved with a bare floor.

A performance of IIC 57 is achieved with a floor covering of 4mm cushion-backed vinyl.

A performance of IIC 72 is achieved with a floor covering of 40oz cut pile carpet loose laid on 8mm foam underlay.

Note: See page 90 for perimeter details.

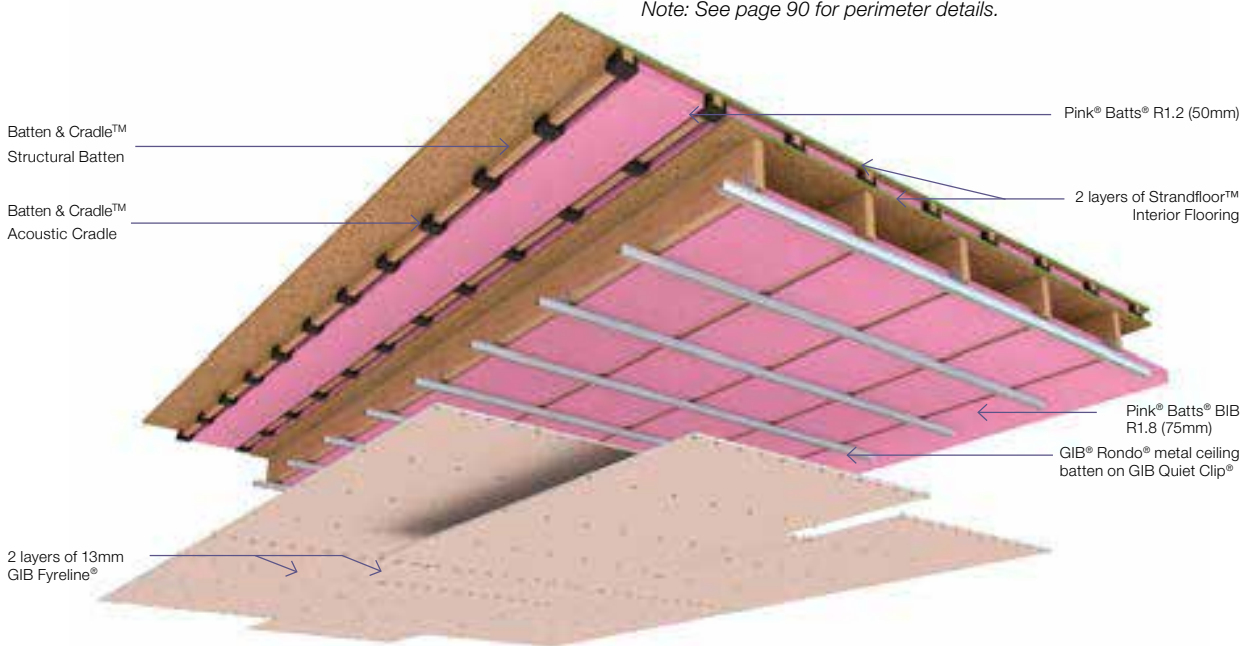

CONSTRUCTION DETAIL

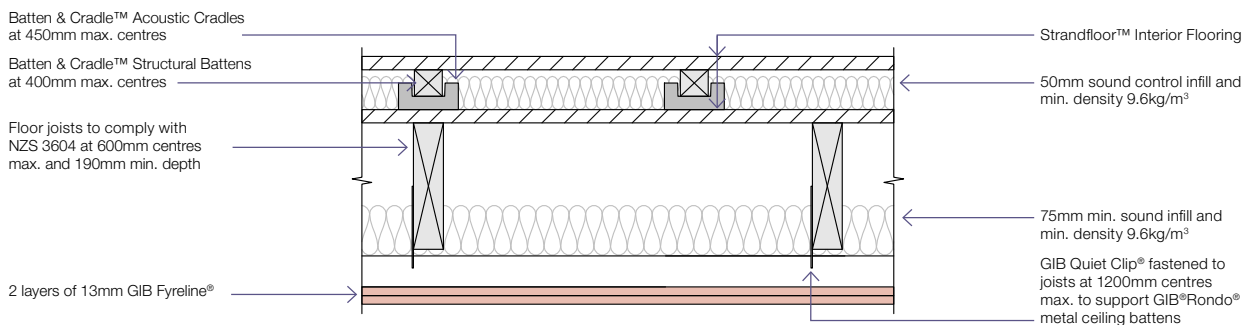

GNS021

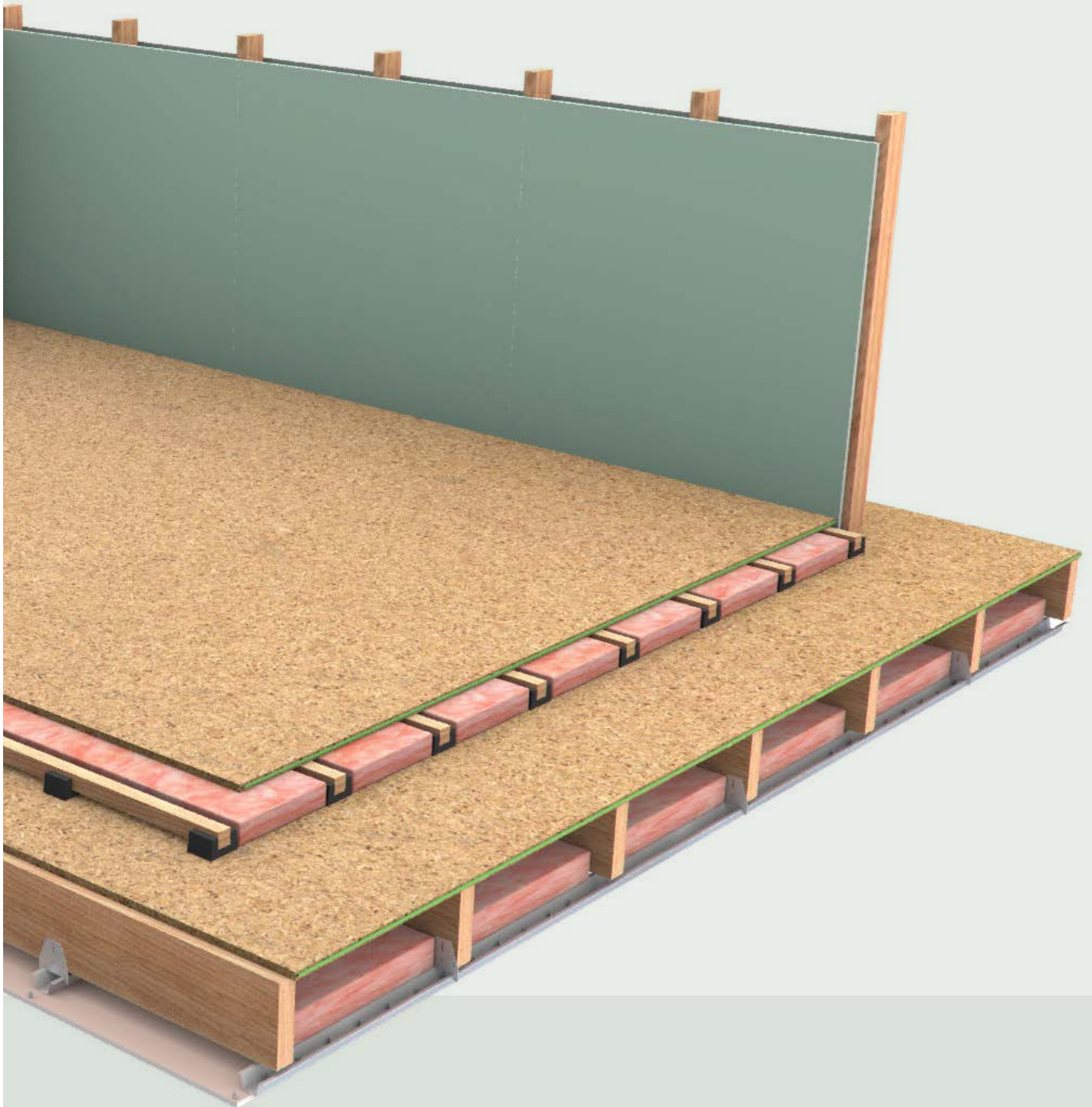

When specifying or installing Laminex New Zealand® product, ensure you have the current technical manual. If you are not sure you do, or you need more information, visit www.laminexnewzealand.co.nz or call Laminex New Zealand® on 0800 303 606.

Laminex
New Zealand®

6.1 Strandfloor® Second Layer – Batten & Cradle™ AcoustiFlor™ System (Floating floor)

- o Position the AcoustiFlor™ cradles on the floor starting from one edge of the room. The cradles allow the placement of Batten & Cradle™ AcoustiFlor™ structural battens.
- o Acoustic cradles must be placed at 450mm centres maximum along the length of Batten, and Batten rows at 400mm centres. Minimum requirements are 7 cradles/m² of the floor area (refer figure 4).
- o AcoustiFlor™ Cradles and structural battens are placed along the perimeter of the room with a 10mm gap from the internal lining (refer figures 3 and 7).
- o Place the AcoustiFlor™ structural battens into the Acoustic cradle. The maximum spacing between the AcoustiFlor™ structural battens must not exceed 400mm centres. The battens can run in either direction of the room i.e. independent of the floor joists or Strandfloor® / StrandfloorH3.1® layout.
- o Acoustic insulation 75mm thick (density 9.6kg/m³ minimum) must be placed in between the batten and cradles to create a damping effect (refer figure 5).
- o Lay Strandfloor® or StrandfloorH3.1® Tongue and Groove across the batten and fix to the battens using a 45mm x 8g self-tapping steel screws. Fixing centres are 150mm for sheet perimeter and 200mm centre of sheet (intermediate area) (refer figure 2).
- o The long sheet edges are to be butted together to form a tight tongue and groove joint (refer figure 6).
- o Allow a 5-8mm gap between the Strandfloor® Tongue and Groove and the wall lining around the perimeter. The gap is filled with a PEF rod and sealed with acoustic sealant (refer figures 6, 7 & 10).
- o Gluing of Strandfloor® Tongue and Groove panels to AcoustiFlor™ structural battens is not mandatory.

6.2 Wet areas

For installation of StrandfloorH3.1® in wet areas follow details as described in 6.1 above, and if rigid floor coverings (e.g. ceramic tile), are being installed please follow details below:

- o A suitable tile & slate fibre cement sheet underlay and the application of an appropriate waterproof membrane shall be installed over the Strandfloor® prior to installation of rigid floor coverings, such as ceramic tile (refer to figure 6 & 7).
- o In wet areas, Strandfloor® panels shall be covered with a floor covering or finish that is impervious (i.e. does not allow the passage of moisture).

While Acceptable Solution E3/AS1 provides a list of impervious surface finishes that meet the requirements of the NZBC, Laminex New Zealand® believe that the laying of an appropriate (1) wet area membrane in accordance with the Code of Practice for Internal Wet Area Membranes prior to the installation of any decorative surface, is best practice to ensure the Strandfloor® will remain dry for the life of the structure.

C6.1 Refer to Laminex New Zealand Strandfloor® Technical Manual Wet Areas 9.3.2 for details on impervious floor finishes.

Figure 2 Fixing detail

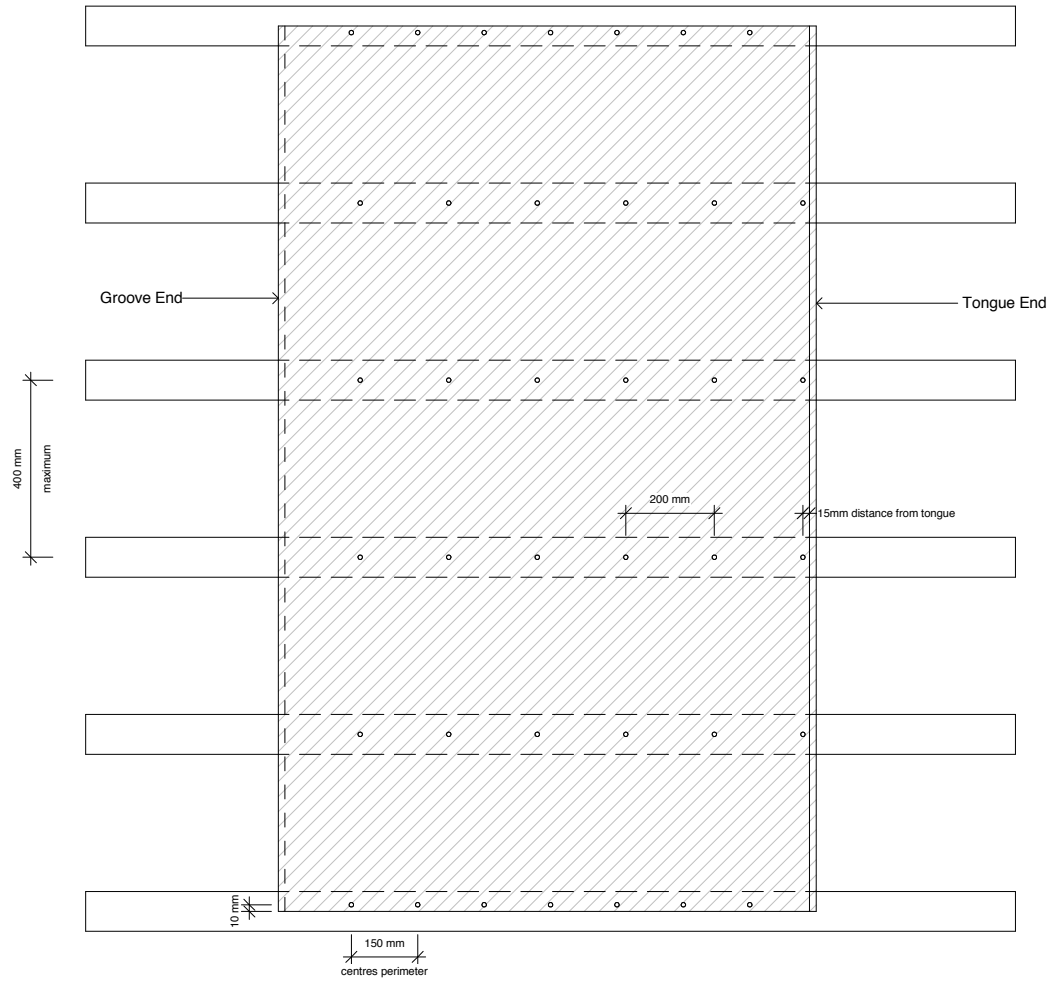

Figure 3 Strandfloor® Joist Layer Installation

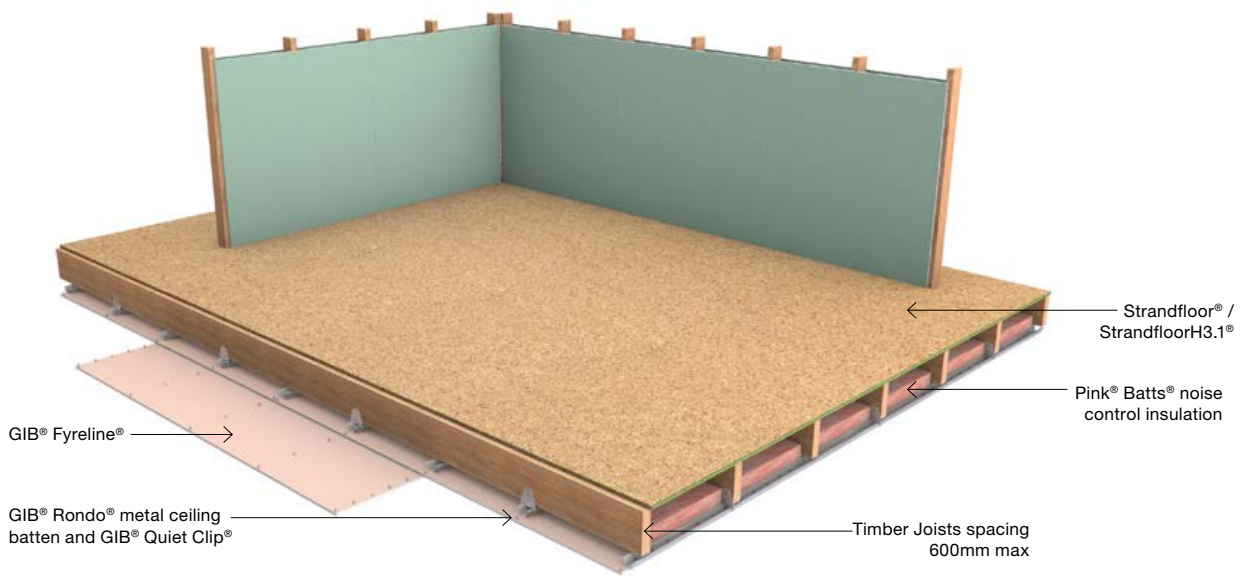

Figure 4 Batten & Cradle™ Flooring System set up

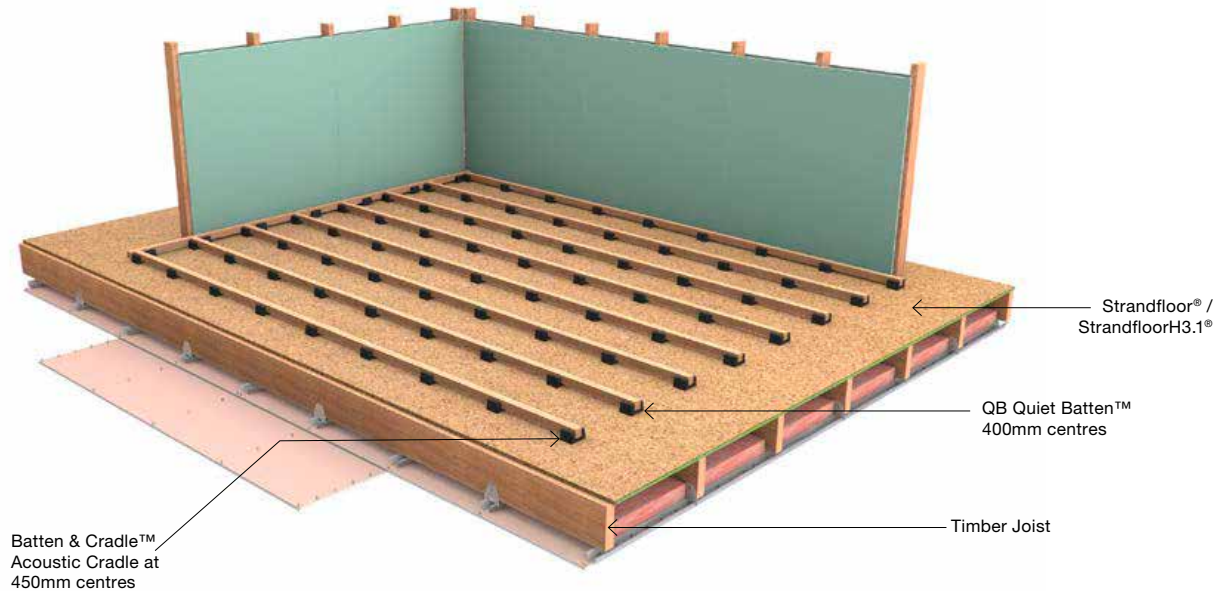

Figure 5 Acoustic insulation 9.6kgs /m³

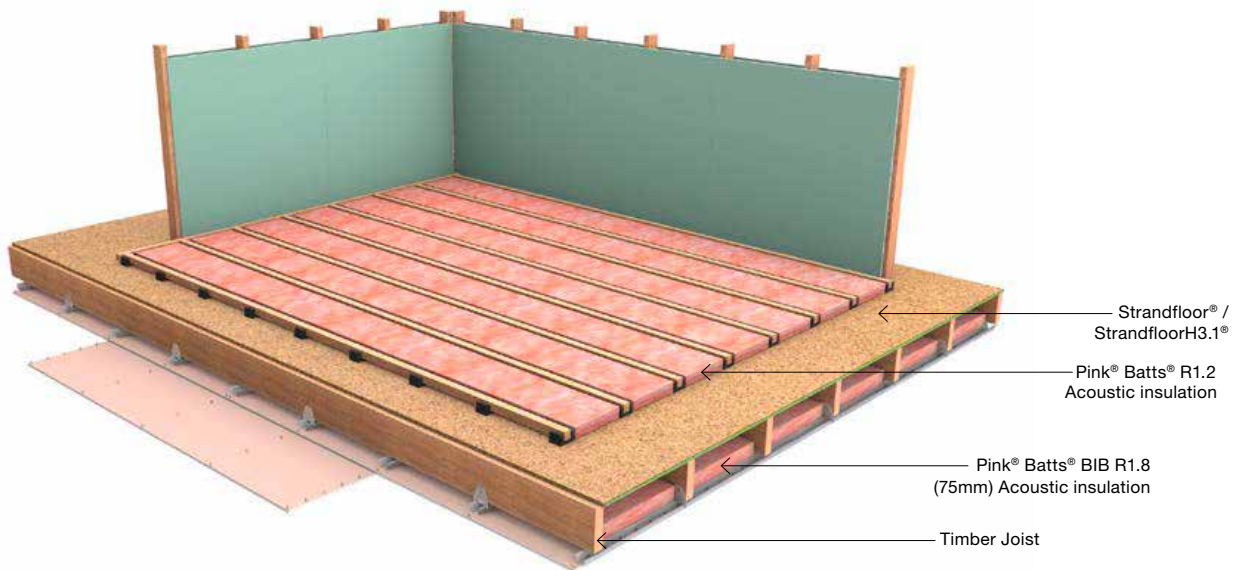

Figure 6 Strandfloor® second layer installation

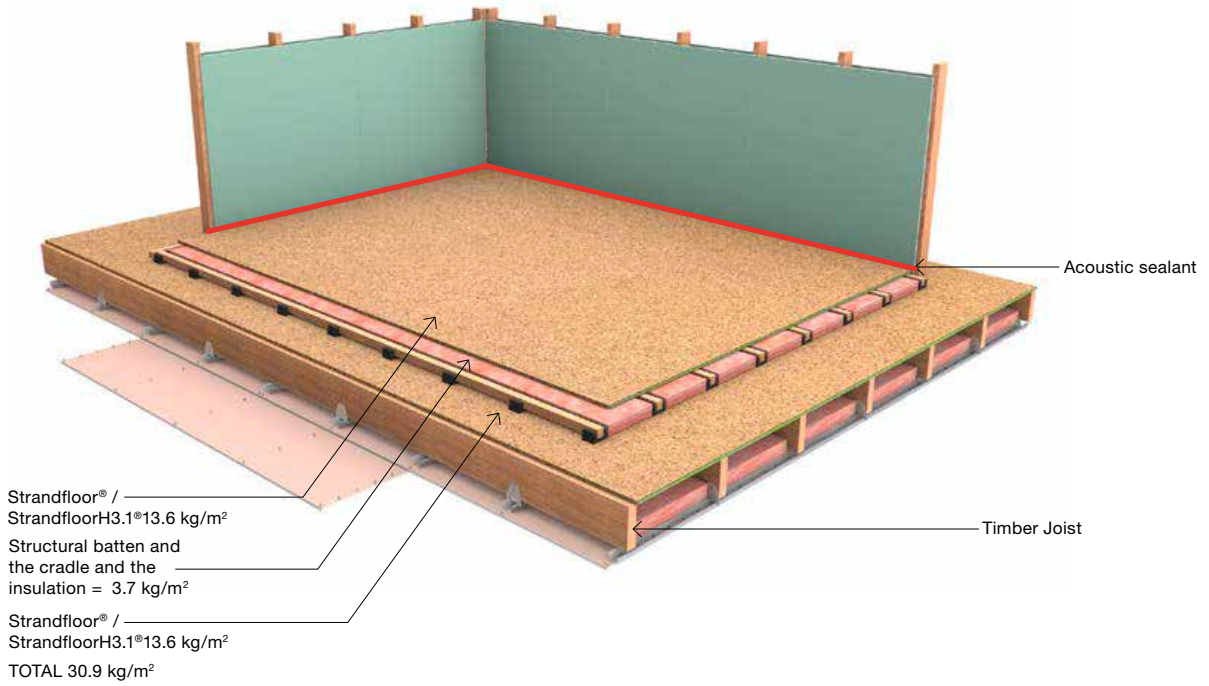
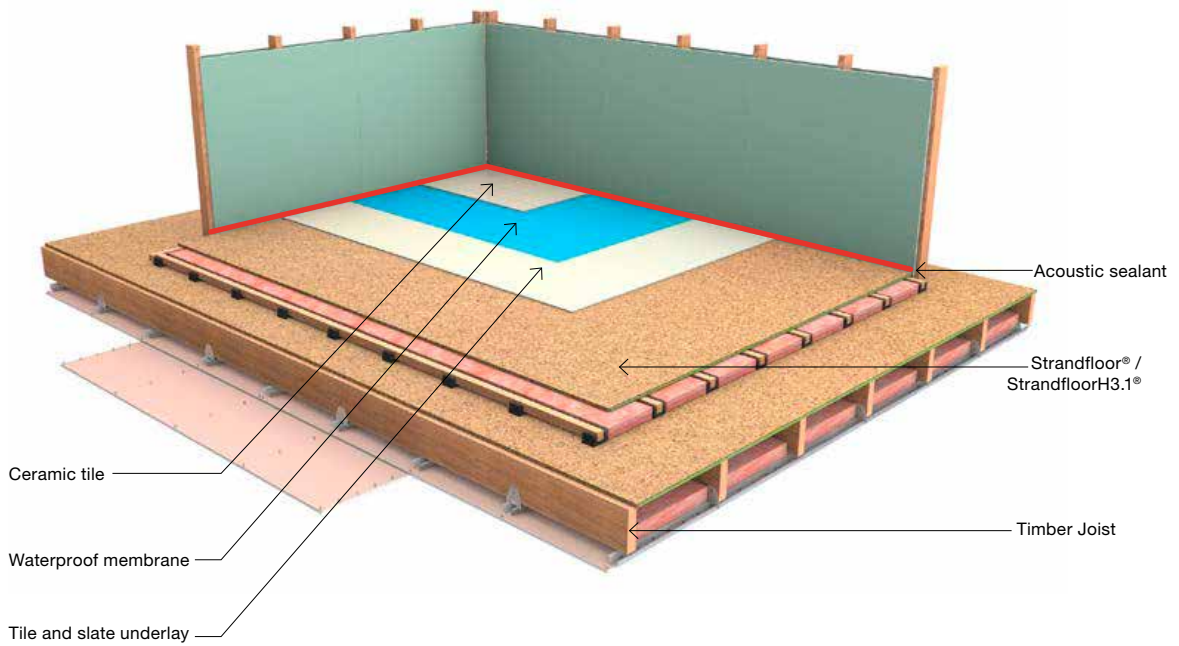

Figure 7 Strandfloor® Wet Area



6.2.1 Shower tray detail

Please refer to Laminex New Zealand® Strandfloor® Technical Manual section 9.3 for further wet area installation details.

6.2.2 Acrylic shower tray detail

Refer figures A, B, C, D

Figure A Services running parallel to floor joists

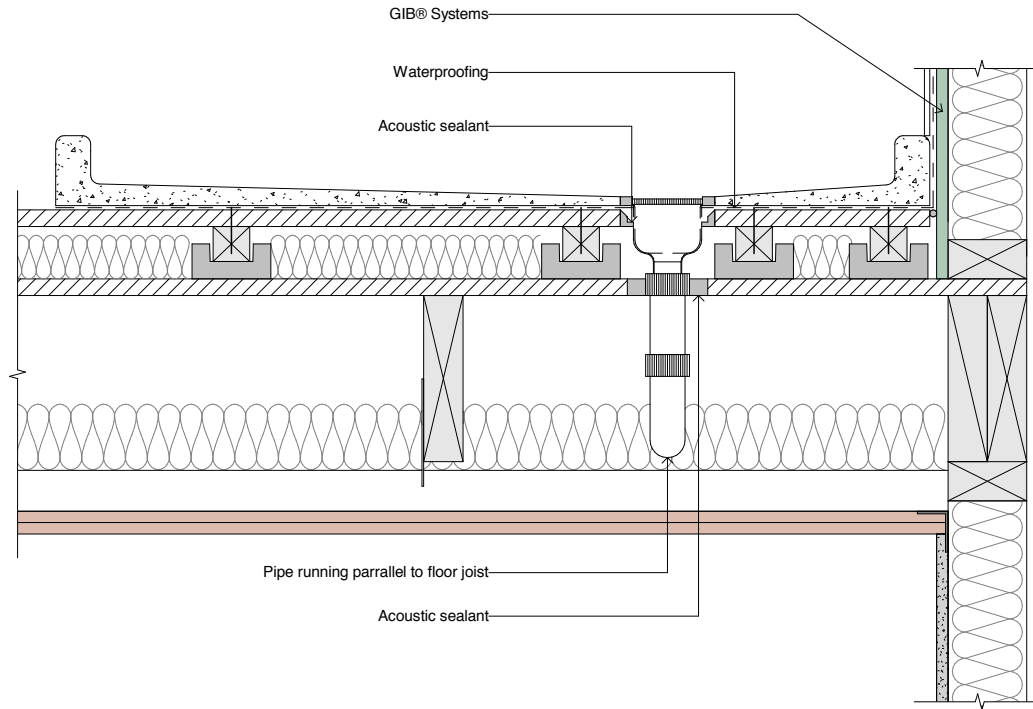
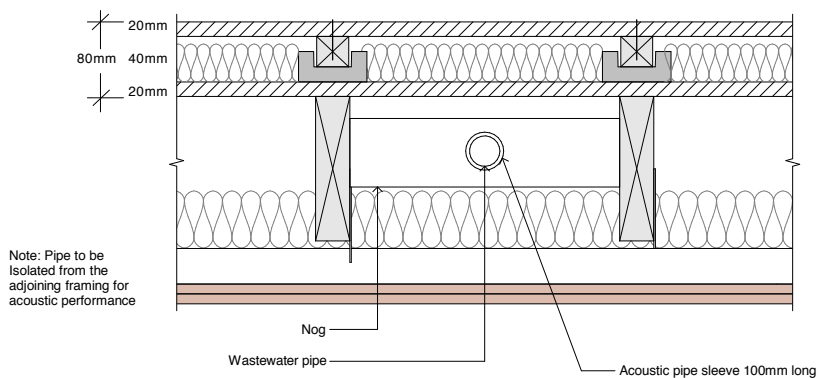
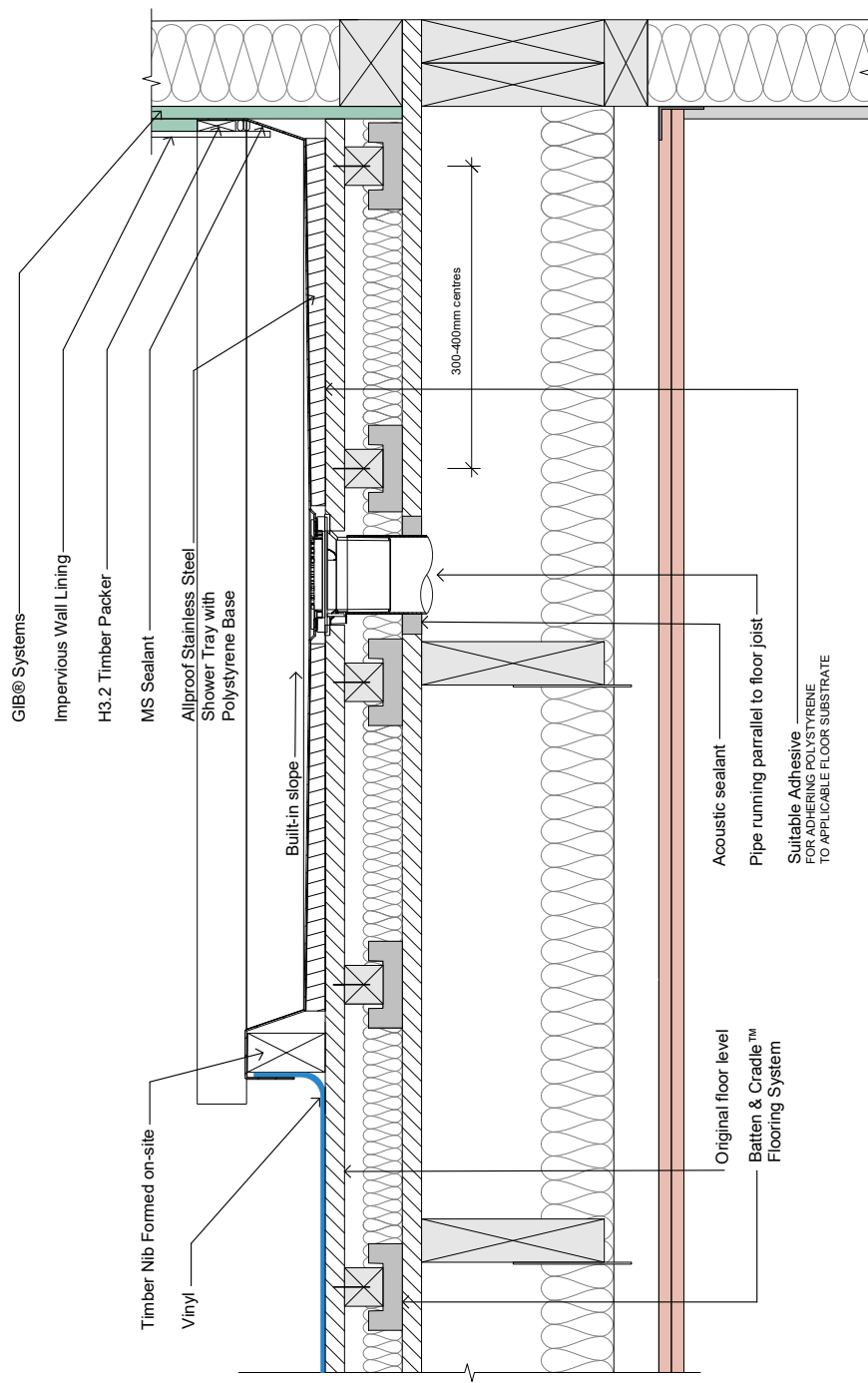

Figure B





All Dimensions are to be site checked before construction and installation

File:	Reference:
Scale: 1 : 5	LSFFA008
Date: 13 Feb 2020	

Laminex® Strandfloor
Level entry or tiled shower base option 1

© copyright 2018 Laminex

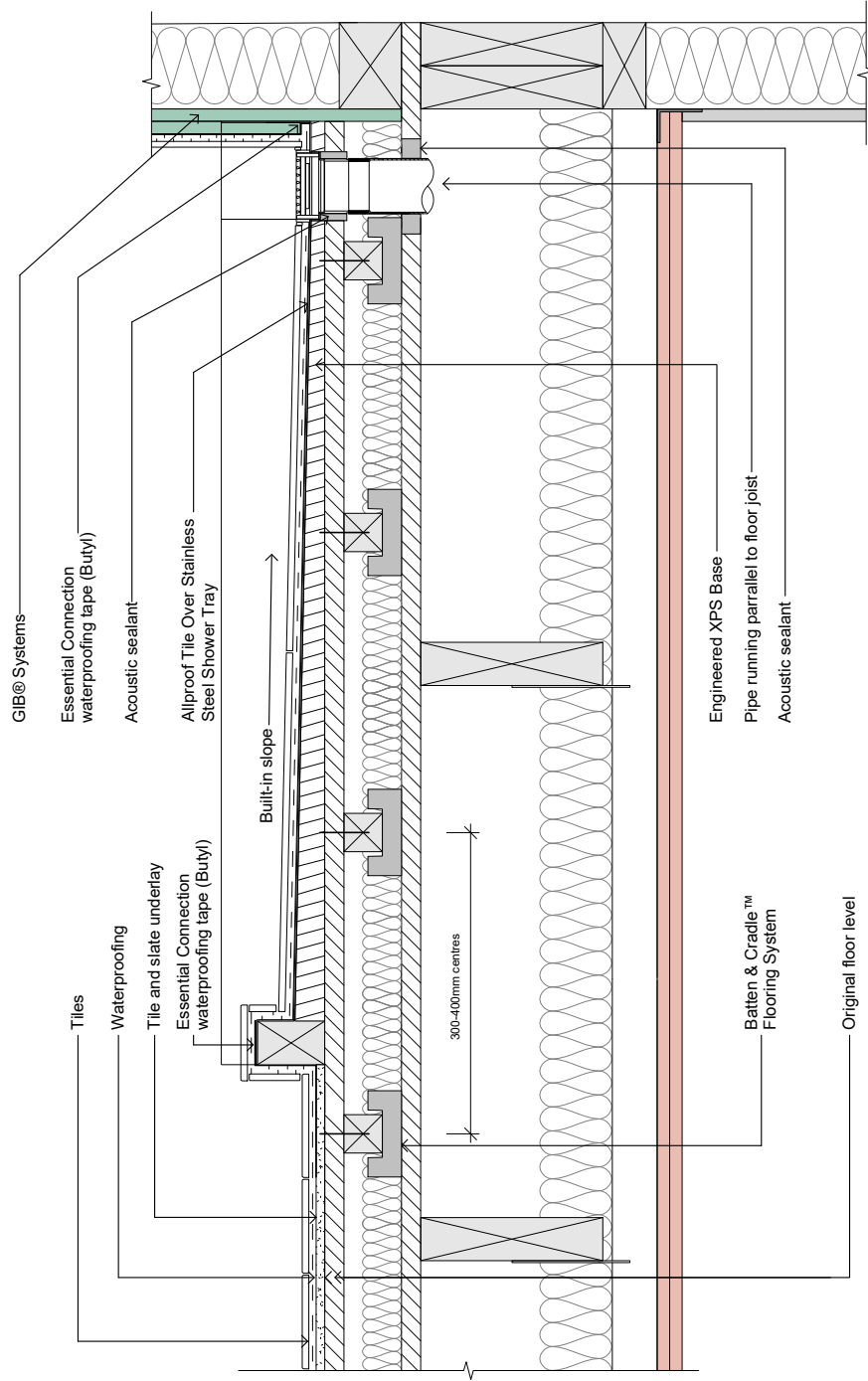

All Dimensions are to be site checked before construction and installation

File	Reference
Scale: 1 : 5	LSFFA008
Date: 13 Feb 2020	

Laminex Strandfloor
Level entry or tiled shower base option 1

© copyright 2018 Laminex

Figure C Services running through floor joists

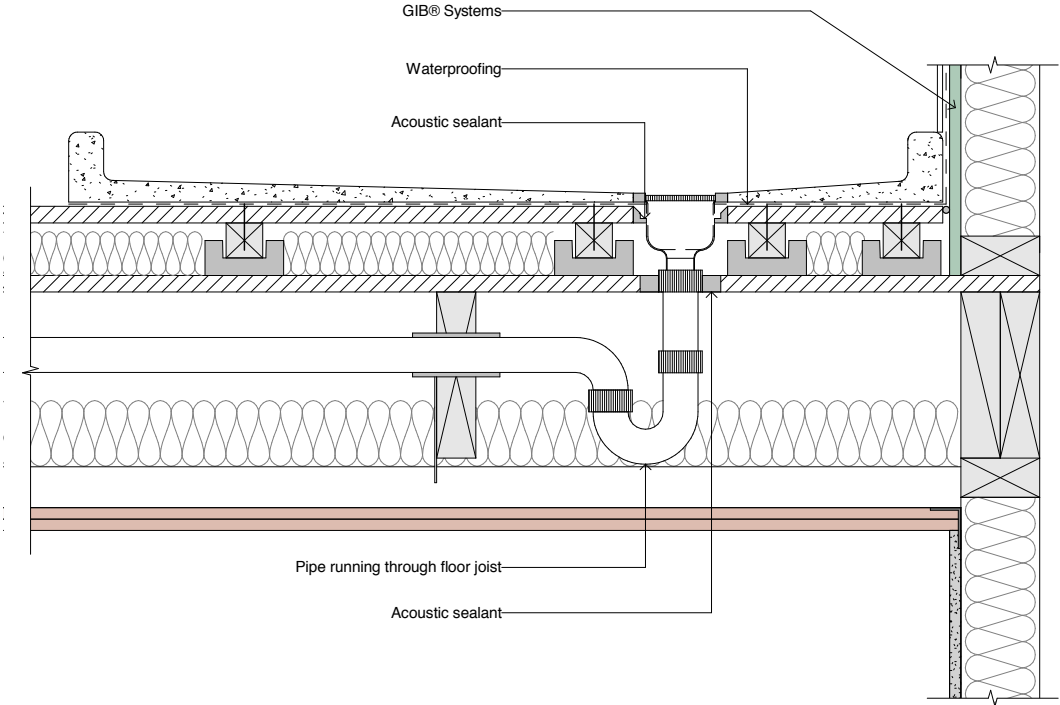
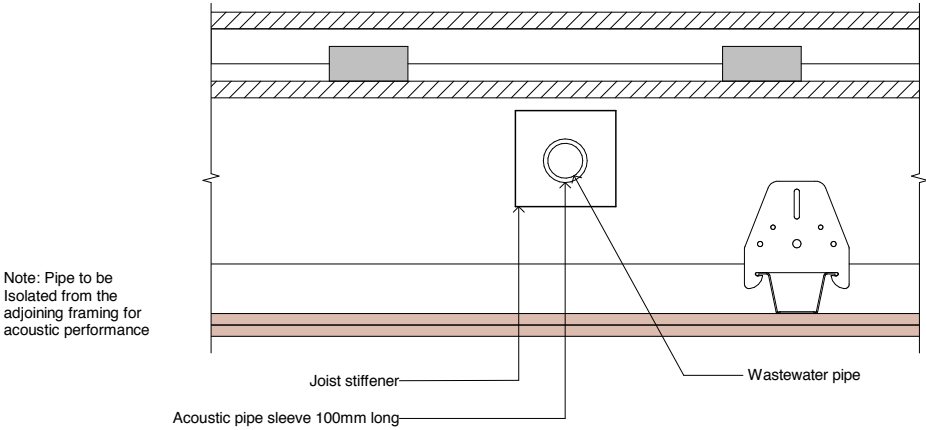

Figure D



6.2.3 Atlantis level entry shower tray detail

Refer E and F.

Atlantis have developed a level entry shower base system which provides a solution for a waterproof joint at the shower base and Strandfloor® junction. This allows for the installation of rigid floor covering, such as ceramic tiles and other impervious floor coverings where level entry is desired. For further details on the Atlantis level entry shower base please contact Atlantis.

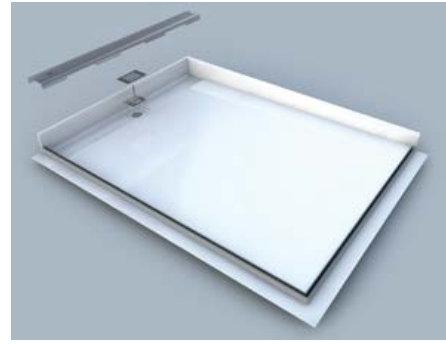

Atlantis Linea Quattro Tiled Channel Drain Shower System

100% waterproof, structurally solid preformed FRP base. 100mm high upstand from the floor and 65mm waterproofing flange at front of the tray for secure waterproofing connection. Factory-fitted glass receiver channels on base. Includes new aquaPLANE™ waste for optimal drainage. Over 60 Standard sizes available. Contact Atlantis for details: Call 0800 428 526 or visit www.atlantis.net.nz.

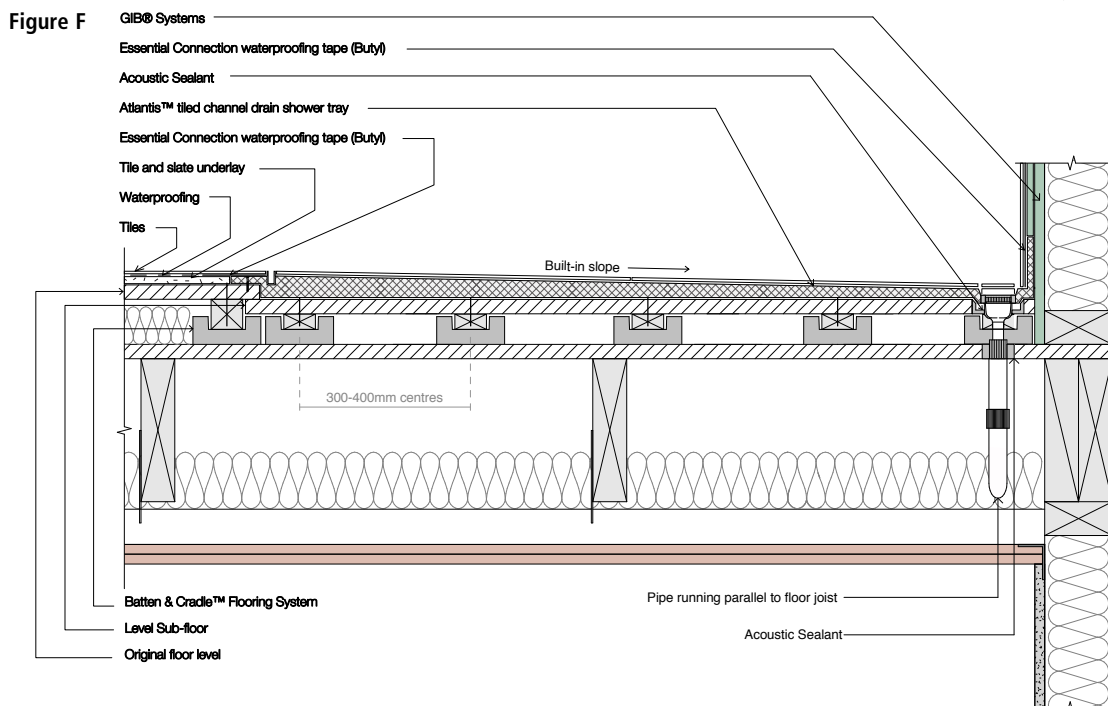
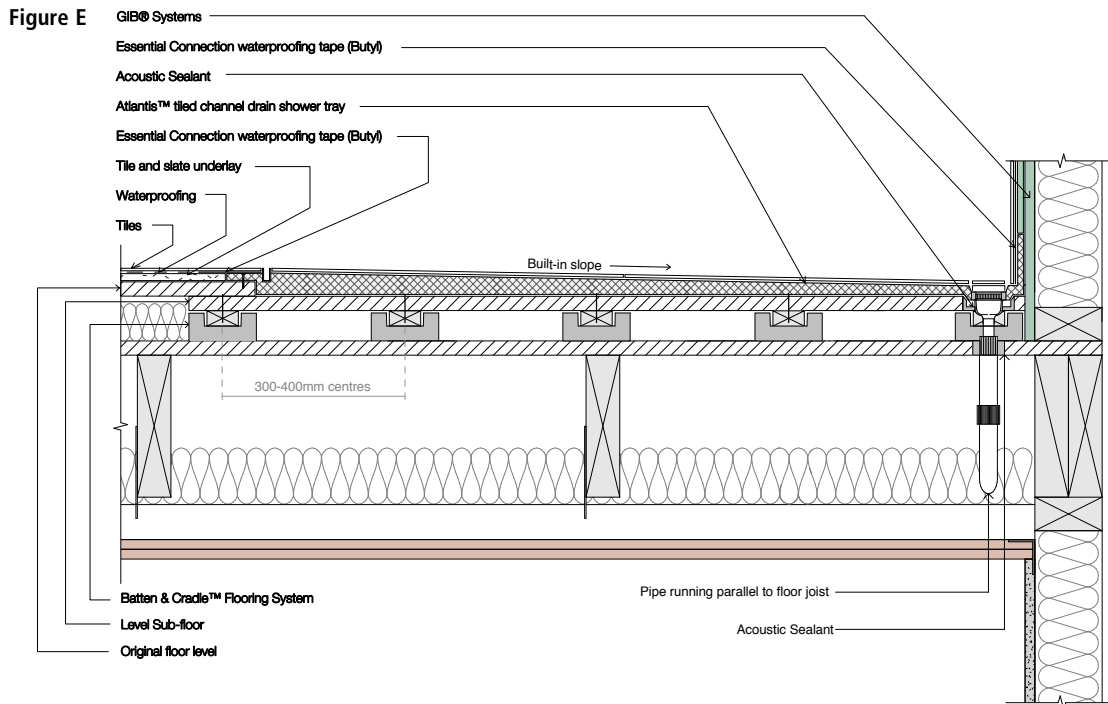

6.3 Ceiling installation

The installation of the GIB® Quiet Clip®, GIB® Rondo® metal ceiling batten and 2 x 13mm GIB® Fyreline® is as per the information published by Winstone Wallboards Limited. Refer to GIB® Noise Control® Systems technical specification for information regarding their installation.

6.4 Floor Penetrations

For smooth clean cut circular holes:

- o For pipe penetrations through the floor cut a 10mm oversize hole through the Strandfloor®. Fit the pipe through the penetration and then seal around with an acoustic sealant.

For irregular holes:

- o Use of a jigsaw or reciprocating saw.
- o Small rectangle or circular holes can be cut by drilling a series of small holes around the perimeter of the hole then tapping out the waste from the sheet face.

Pipe Penetration Details – Structural Support

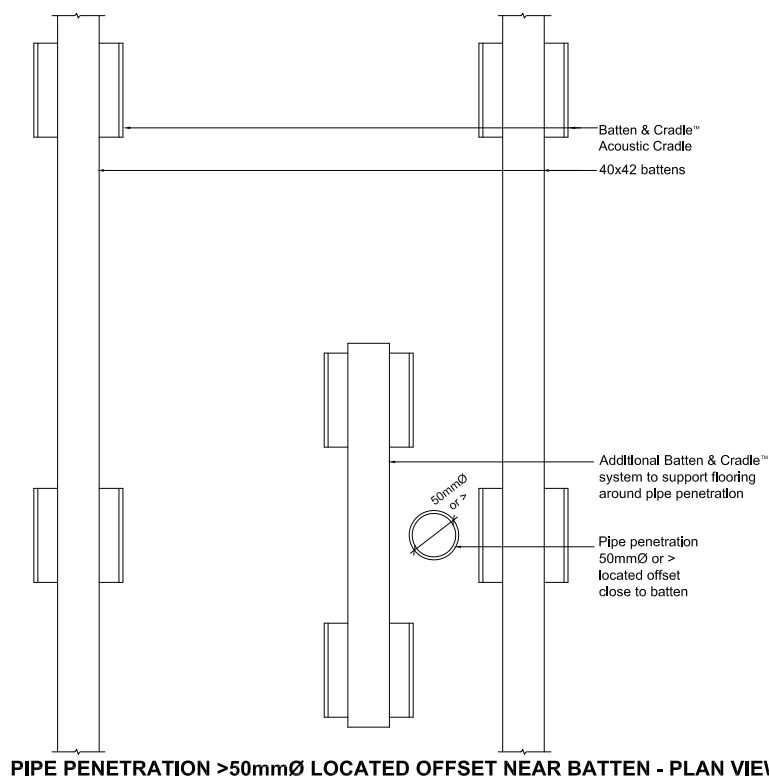

Note:
Representative Example of Structural Detail
Please refer to Batten & Cradle "Acustifloor"™ Technical Department for any further options needed

Pipe Penetration >50mmØ Located offset near batten – Plan view

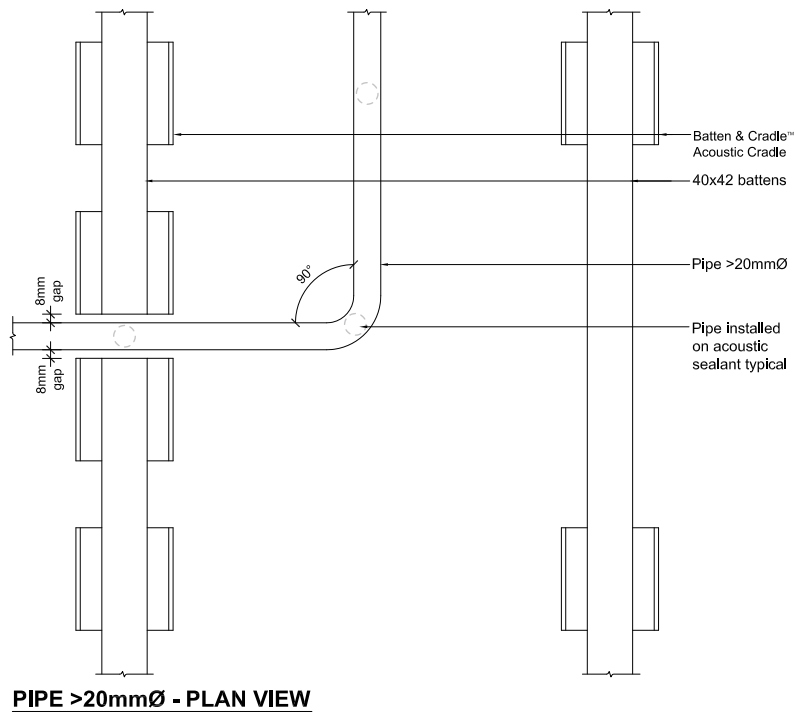

Pipe >20mmØ – Plan view

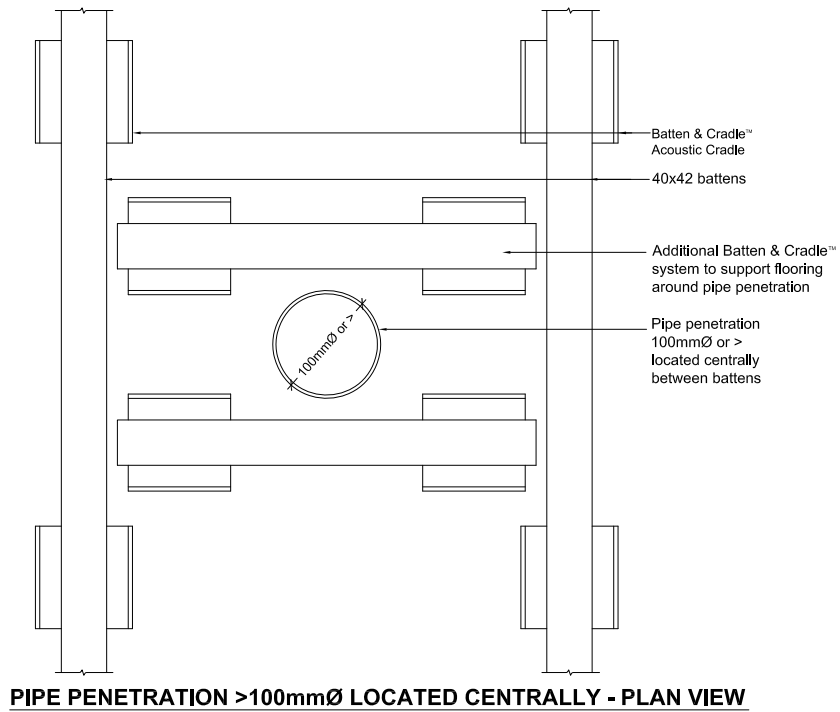

Pipe Penetration >100mmØ Located centrally – Plan view



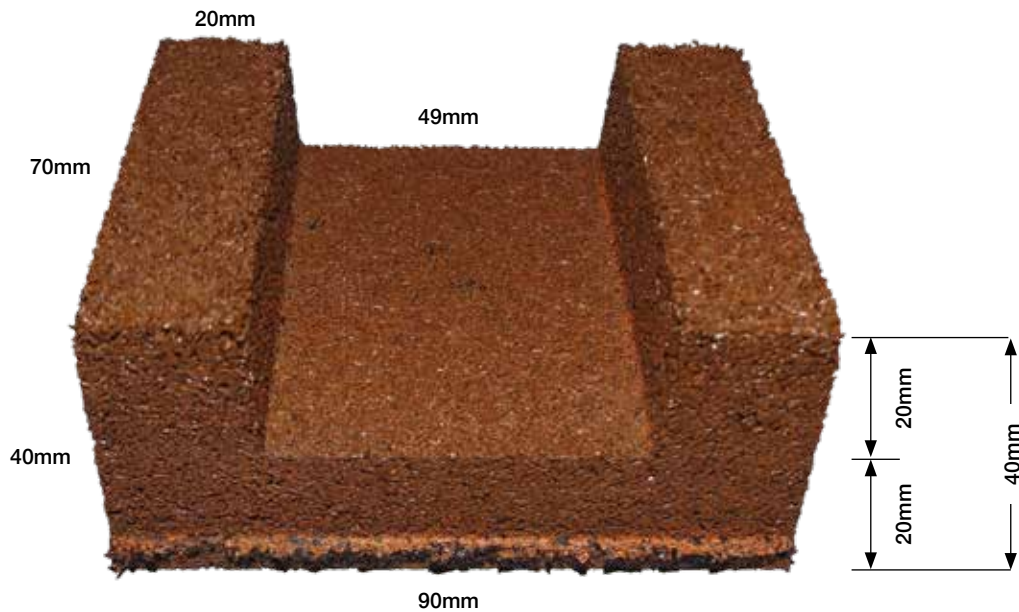

- Manufactured from reclaimed rubber and or recycled rubber.
- Bonded using blocked resin formulation to help prevent any reaction with membranes
- 25 year warranty (see website for full details)
- Cradle sits directly on membrane with no adhesive or fastener required between cradle and the membrane
- Designed to take P&G H3.2 timber for external use.
- P&G 50mm thick timber is recommended, achieving a tolerance of 1mm either side in the Cradle.
- Sawn 50mm timber can be used and tightly fitted inside the cradle.
- Dekcradle™ can be used for both internal and external applications.
- Brown in colour to ensure product identification.

Note

DekCradle™ has been designed primary for external use. DekCradle has limited acoustic properties and should be only used for it's intended purpose.



Basic Specifications

- Construction should always conform to accepted building practices and NZS 3604, and this must always be checked, if in doubt.
- Batten or joists should be a minimum of 50mm wide and 40mm high. Most use 100 x 50 MSG No1 KD for internal use.
- If used outside, minimum treatment of H3.2 CCA.
- Cradles maximum spacing of 450mm centres, and are not glued or fastened to membrane.
- Battens maximum spacing of 400mm centres.
- Fastenings of deck or other overlay materials are to be as per manufacturers specifications.

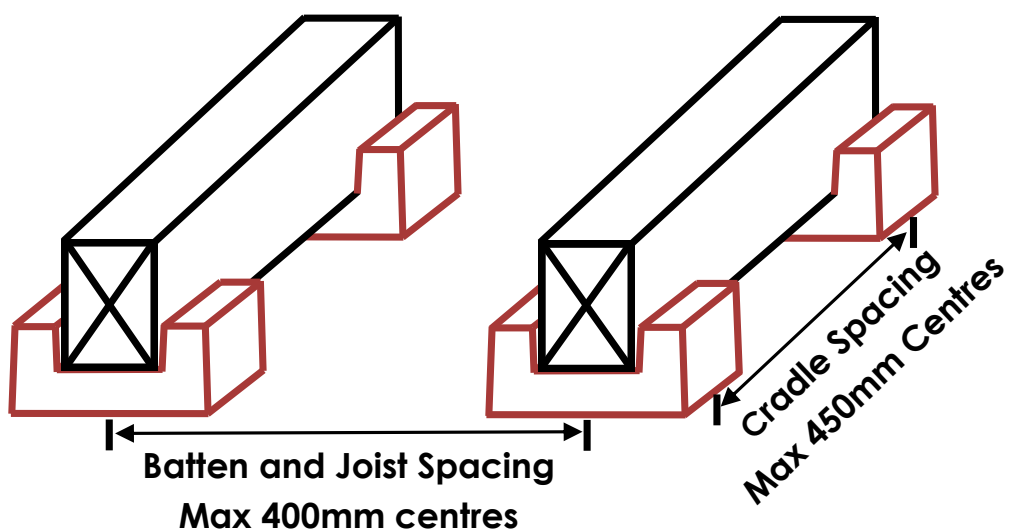



Easy to install



How Many DekCradles Do I Need For My Deck?

We recommend 7-10 cradles** per m² for your deck. This is subject to shape of floor area and layout of the cradles.

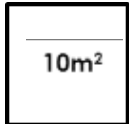

Square shaped area may use: Approximately **7 cradles** per m².

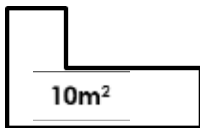

Other deck shapes with the same square metres but more edges, may use: Approximately **10-12 cradles** per m².

* Edging requires support to a minimum of 100 mm.

**We are conservative in our recommendation figures. Cradles required varies from 7-8 cradles per m² in large open areas, and up to 10 cradles per m² where situations call for more.

Based on this information, table below has been calculated based on 10 cradles per m². (Subject to shape of deck)

DekCradles Per Square Metre										
Square Metre Job										
	10	20	30	40	50	60	70	80	90	10
Number of Cradles (Recommended)										1000
									900	
								800		
							700			
						600				
					500					
				400						
			300							
		200								
	100									

DekCradles are available at selected building merchants nationwide. Phone our office to find your nearest supplier. (Cradles are supplied in strips of 13 per strip.) Subject to Volume.





DekCradle™

Deck Timber Support

Protects roofing membrane - safely lay on top of trafficable waterproof membranes

Made of recycled rubber

Sits on the membrane surface with no need for glue

Easy to use

Keeps joists and timber out of surface water

Lower noise transmission to lower levels

ARDEX Australia Pty Ltd
20 Powers Road
Seven Hills NSW 2147
Tel: (02) 9851 9199
Fax: (02) 9674 5621
Email: techinfo@ardexaustralia.com
Internet: www.ardex.com

ARDEX New Zealand Ltd
32 Lane St, Woolston
Christchurch, New Zealand
Tel: (03) 373 6900
Fax: (03) 384 9779
Internet: www.ardex.co.nz

DekCradle™

Deck Timber Support

PRODUCT DESCRIPTION

The DekCradle™ is a support for deck timber over waterproofing membranes and complies with NZ Building Code, Clause E2/AS1 7.3.1.2. Designed to elevate a deck from the waterproofing membrane, DekCradles allow a floating deck to be installed with no risk of damaging the membrane below.

The DekCradle™ sits directly on the membrane. No glue, adhesive or fasteners of any kind are necessary between the DekCradle™ and the membrane.

Made from recycled rubber the DekCradle™ does not contain solvents and is a fully blocked resin formulation to guard against reaction with all membranes.

The DekCradle™ was designed to take 50mm thick H3.2 timber for external use.

The dimensions of 100mm x 50mm nominal give a 47mm finish allowing 1mm either side inside the cradle. This allows the timber bearers to be removed for trimming without disturbing the cradle position.

The DekCradle™ can be used both internally and as per its specific design for exterior use.

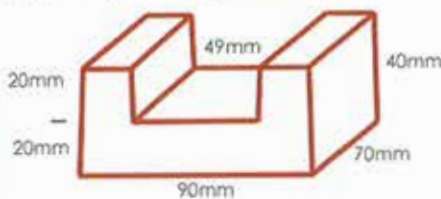

BASIC SPECIFICATIONS

Construction should always conform to accepted building practices and NZS 3604 - this must always be checked, if in doubt.

Batten or joists should be a minimum of 50mm wide and 40mm high. Most use 100mm x 50mm MSG No1 KD for internal use.

If used outside, minimum treatment of H3.2 CCA is recommended. The spacing between the centres of two cradles should not exceed 450mm (see drawing). The cradles are not glued or fastened to the membrane.

The battens maximum spacing is 400mm (again from the centre of one cradle to the centre of the next).

Fastenings of deck or other overlay materials are to be as per manufacturers specifications.

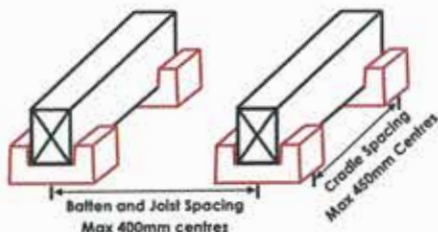

INSTALLATION

- The site must be clean and free of waste.
- Most builders will use a laser level to verify level placement.
- Plan the layout of your cradles to meet the spacing of no more than 450mm centres in length, and no greater than 400mm centres in width.
- Ensure a cradle is placed no greater than 50mm from an outside extremity, to ensure load support is covered around external edges.
- Cradles must be laid parallel.
- Joists may need to be ripped to make up for variations in floor height or for fall of deck surface.
- If floor surface is not level, use timber or ply H3 treated shims, or wedges within the DekCradle™ to place under the joists, from either end of the cradle.
- Connect the shim, with a dob of timber approved glue, to the joist, not the DekCradle.
- The shim cannot be packed up higher than 10mm.
- Do not shim between floor surface and the bottom of DekCradle™. Place all joists in the DekCradle, and check for level. The extreme between timber and side of cradle is planned.
- Install your decking or chosen surface following the appropriate building practice and product specifications. Please check before installation for the appropriate fastenings specifications.
- All fastenings of your top surface material must be connected to only the joist, not the DekCradle™ as per manufacturers instruction.



ARDEX Australia Pty Ltd

Technical Services Toll Free: 1800 224 070

NSW	Ph (02) 9851 9100	Fax (02) 9838 7970
QLD	Ph (07) 3817 6000	Fax (07) 3881 3188
VIC/TAS	Ph (03) 9308 9255	Fax (03) 9308 9332
SA	Ph (08) 8268 2511	Fax (08) 8345 3207
WA	Ph (08) 9256 8600	Fax (08) 9455 1227

ARDEX New Zealand Ltd

Technical Services Toll Free: 0800 227 339

Auckland	Ph (09) 636 0005	Fax (09) 2967 689
Wellington	Ph (04) 5685 949	Fax (04) 5686 376
Christchurch	Ph (03) 373 6900	Fax (03) 3849 779

DISCLAIMER

The technical details, recommendations and other information contained in this data sheet are given in good faith and represent the best of our knowledge and experience at the time of printing. It is your responsibility to ensure that our products are used and handled correctly and in accordance with any applicable New Zealand & Australian Standards, our instructions and recommendations and only for the uses they are intended. We also reserve the right to update information without prior notice to you to reflect our ongoing research and development program. Country specific recommendations, depending on local standards, codes of practice, building regulations or industry guidelines, may effect specific installation recommendations. The supply of our products and services is also subject to certain terms, warranties and exclusions, which may have already been disclosed to you in prior dealings or are otherwise available to you on request. You should make yourself familiar with them. All aforementioned products are the trade marks of ARDEX New Zealand Ltd and Batten & Cradle Flooring Systems Ltd.



Engineered solutions
for tiling, flooring and
waterproofing projects

ACCESSORIES

For use with ARDEX Butynol, EPDM, TPO, Undertile
and Bituminous Torch On Waterproofing Membranes



ACCESSORIES

ADDITIONAL ITEMS

<p>10522 Rubber Roller</p>  <p>For detailing sheet membranes</p>	<p>8000007 Probe</p>  <p>For checking welds on TPO membranes</p>	<p>10918 Brass Roller</p>  <p>For detailing sheet membranes</p>	<p>8000007 Triac PID</p>  <p>Digital micro processor temperature control</p>
<p>10465 Long Handle Roller</p>  <p>For detailing sheet membranes</p>	<p>10801 Pressure Bar</p>  <p>For terminating sheet membranes</p> <p>38mm x 2.4m long</p>	<p>22154 Plunger Can</p>  <p>Convenient solvent dispenser</p>	<p>8000007 Uniroof E</p>  <p>Hot air welding machine</p>
<p>13264 Green Right Mix Bucket</p>  <p>20 litre mixing bucket</p>	<p>11030 Water Gauging Bucket</p> 	<p>73201 30L Mixing Bucket</p> 	
<p>8000007 Verticell</p>  <p>Drainage system for ARDEX Living Roof Systems. Available on indent order.</p>	<p>19492 Deck Cradle</p> 	<p>8000007 Triac S</p>  <p>Manual temperature control</p>	



ARDEX New Zealand Ltd Ph 0800 2 ARDEX www.ardex.co.nz



AcoustiFlor™**August 2014**

Batten & Cradle™ Living Standards' Product is stable and will achieve the acoustic standards recorded in laboratory tests as set out in the Product literature where it is properly installed. However, acoustic performance for each installation is site specific and the level of acoustic performance achieved will require the customer's own acoustic engineer's assessment of all factors affecting acoustic performance. The customer's own acoustic engineer must set the level of acoustic performance to be expected. Batten & Cradle™ warrants that for a period of 15 years its Product will not rust, rot, corrode, crack, deform (under normal 1.5kPa live loads), suffer damage from termite attacks, leach, contaminate or combust to the extent published in Batten & Cradle™ Product literature current at the time of installation. Batten & Cradle™ warrants that for the period of 5 years from date of purchase that its Product will be free from defects due to the manufacturing process and raw materials. Nothing in this document shall exclude or modify any rights a customer may have under the Consumer Guarantees Act or otherwise which cannot be excluded or modified at law. This warranty is strictly subject to the following conditions:

Conditions of Warranty:

This warranty is strictly subject to the following conditions:

1. Batten & Cradle™ will not be liable for breach of warranty unless the claimant provides proof of purchase and makes a written claim within 30 days after the defect would have become reasonably apparent or, if the defect was reasonably apparent prior to installation, then the claim must be made prior to installation;
2. this warranty is not transferable;
3. the Product must be installed and maintained strictly in accordance with the relevant Batten & Cradle™ literature current at the time of installation and must be installed in conjunction with the components or products specified in the literature. Further, all other products, including coating and jointing systems, applied to or used in conjunction with the Product must be applied or installed and maintained strictly in accordance with the relevant manufacturer's instructions and good trade practice;
4. the project in which the Product is installed must be designed and constructed in strict compliance with all relevant provisions of the current New Zealand Building Code (NZBC), regulations and standards;
5. the claimant's sole remedy for breach of warranty is (at Batten & Cradle's option) that Batten & Cradle™ will either supply replacement Product, rectify the affected Product or pay for the cost of the replacement or rectification of the affected Product;
6. Batten & Cradle™ will not be liable for any loss or damages (whether direct or indirect) including property damage or personal injury, consequential loss, economic loss or loss of profits, arising in contract or negligence or howsoever arising. Without limiting the foregoing Batten & Cradle™ will not be liable for any claims, damages or defects arising from or in any way attributable to poor workmanship, poor design or detailing, settlement or structural movement and/or movement of materials to which the Product is attached or adjoins, incorrect design of the structure, act of God including but not limited to earthquakes, cyclones, floods or other severe weather conditions or unusual climatic conditions, efflorescence or performance of paint/coatings applied to the Product, normal wear and tear, growth of mould, mildew, fungus, bacteria, or any organism on any Product surface or Product (whether on the exposed or unexposed surfaces);
7. all warranties, conditions, liabilities and obligations other than those specified in this warranty are excluded to the fullest extent allowed by law;
8. if making a claim under this warranty involves recoating of other materials then there may be slight colour differences due to the effects of weathering and variations in materials over time. Batten & Cradle™ is not liable for any such colour variations.

Defined Terms used in this document:

"AcoustiFlor" is the protected trade name for Batten & Cradle™ Flooring Systems Limited and use of this trade name within this document means Batten & Cradle™ Flooring Systems Limited. "Batten & Cradle" has the same meaning.

"Product" means the AcoustiFlor™ AC20 (black) moulded rubber cradle.

End of warranty

DekCradle™**August 2014**

Batten & Cradle™ Living Standards' Product is stable and will last a very long time! Batten & Cradle™ warrants that for a period of 15 years its Product will not rust, rot, corrode, crack, deform (under normal 1.5kPa live loads), suffer damage from termite attacks, leach, contaminate or combust to the extent published in Batten & Cradle™ Product literature current at the time of installation. Batten & Cradle™ warrants that for the period of 5 years from date of purchase that its Product will be free from defects due to the manufacturing process and raw materials. Nothing in this document shall exclude or modify any rights a customer may have under the Consumer Guarantees Act or otherwise which cannot be excluded or modified at law. This warranty is strictly subject to the following conditions:

Conditions of Warranty:

This warranty is strictly subject to the following conditions:

1. Batten & Cradle™ will not be liable for breach of warranty unless the claimant provides proof of purchase and makes a written claim within 30 days after the defect would have become reasonably apparent or, if the defect was reasonably apparent prior to installation, then the claim must be made prior to installation;
2. this warranty is not transferable;
3. the Product must be installed and maintained strictly in accordance with the relevant Batten & Cradle™ literature current at the time of installation and must be installed in conjunction with the components or products specified in the literature. Further, all other products, including coating and jointing systems, applied to or used in conjunction with the Product must be applied or installed and maintained strictly in accordance with the relevant manufacturer's instructions and good trade practice;
4. the project in which the Product is installed must be designed and constructed in strict compliance with all relevant provisions of the current New Zealand Building Code (NZBC), regulations and standards;
5. the claimant's sole remedy for breach of warranty is (at Batten & Cradle's option) that Batten & Cradle™ will either supply replacement Product, rectify the affected Product or pay for the cost of the replacement or rectification of the affected Product;
6. Batten & Cradle™ will not be liable for any loss or damages (whether direct or indirect) including property damage or personal injury, consequential loss, economic loss or loss of profits, arising in contract or negligence or howsoever arising. Without limiting the foregoing Batten & Cradle™ will not be liable for any claims, damages or defects arising from or in any way attributable to poor workmanship, poor design or detailing, settlement or structural movement and/or movement of materials to which the Product is attached or adjoins, incorrect design of the structure, act of God including but not limited to earthquakes, cyclones, floods or other severe weather conditions or unusual climatic conditions, efflorescence or performance of paint/coatings applied to the Product, normal wear and tear, growth of mould, mildew, fungus, bacteria, or any organism on any Product surface or Product (whether on the exposed or unexposed surfaces);
7. all warranties, conditions, liabilities and obligations other than those specified in this warranty are excluded to the fullest extent allowed by law;
8. if making a claim under this warranty involves recoating of other materials then there may be slight colour differences due to the effects of weathering and variations in materials over time. Batten & Cradle™ is not liable for any such colour variations.

Defined Terms used in this document:

"DekCradle" is the protected trade name for Batten & Cradle™ Flooring Systems Limited and use of this trade name within this document means Batten & Cradle™ Flooring Systems Limited and "Batten & Cradle™" has the same meaning.

"Product" means either or both: AcoustiFlor™ AC20 (black)
DekCradle™ DC20 (brown)

End of warranty

We recommend designers should be familiar with relevant building code requirements and should read this manual to ascertain the extent of the partnership required between themselves and their acoustic engineer in delivering an effective acoustic solution.

Please ensure that the information in this document is appropriate for the application you are planning and that you undertake specific design and detailing for areas that fall outside the scope of this manual.

When specifying Batten & Cradle™ products, ensure you have the current information. Please refer to our website for any changes and additions to all or any of our technical information. We recommend you check to ensure you are using the most current technical information before proceeding

This publication may be superseded by a new publication. Batten & Cradle™ accepts no liability for reliance upon publications that have been superseded. You should check our website to ensure you are using the current publication. If you are unsure whether this is the current publication, simply email sales@bcsystemsint.com

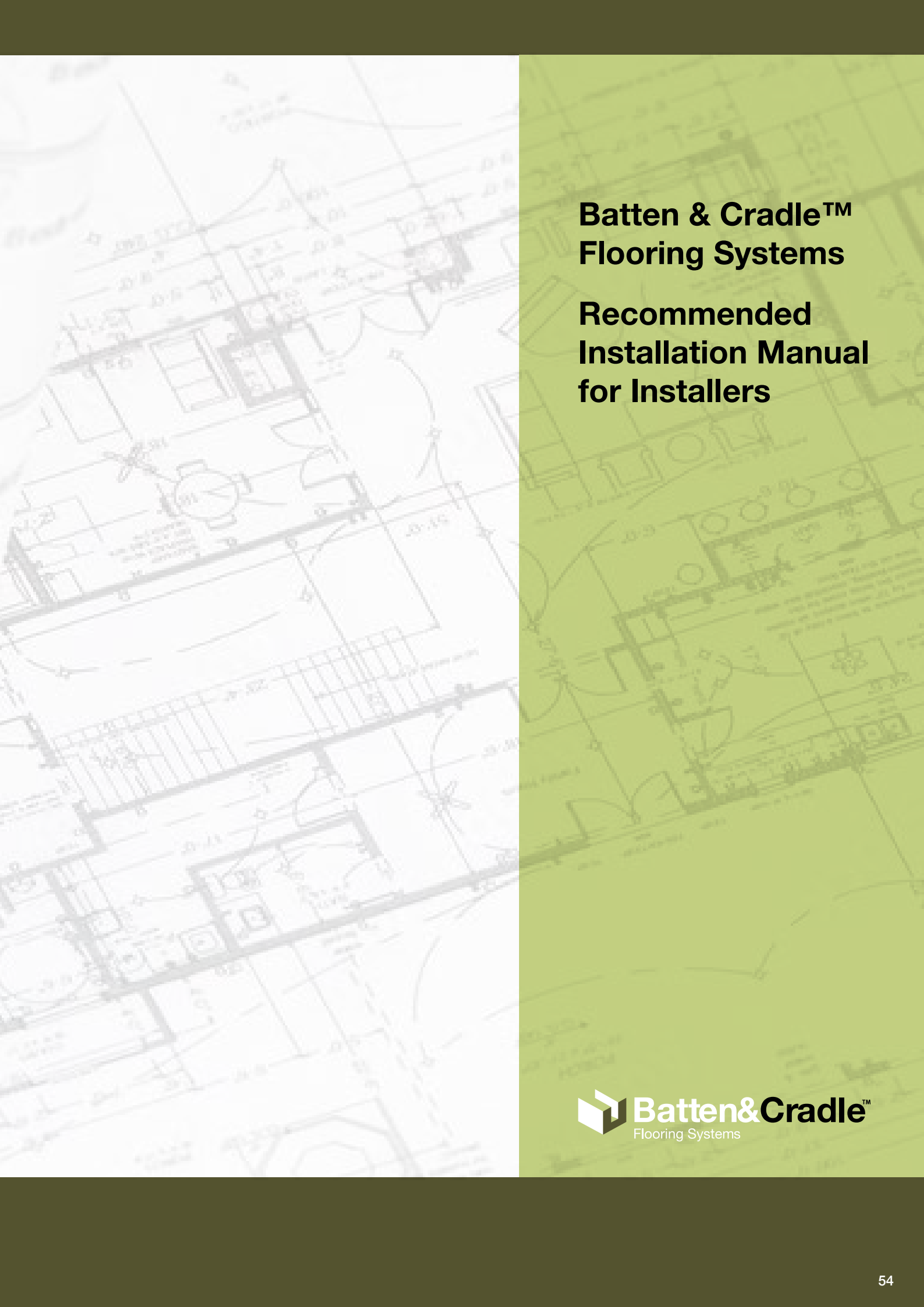
The background of the page is a detailed architectural floor plan, rendered in a light, faded style. It shows various rooms, corridors, and structural elements with lines and text annotations. The right side of the page is overlaid with a solid green color.

Batten & Cradle™ Flooring Systems

Recommended Installation Manual for Installers



Batten & Cradle™ Flooring Systems Recommended Installation Manual for installers

Introduction

Batten & Cradle™ systems are dry floating floors which provide an easily levelled under structure for supporting composite flooring. Concrete ground level supported floors must have a damp proof membrane and screed complying with the appropriate Codes of Practice and Building Regulations.

Storage

All components should be kept inside, under cover and in dry conditions at all times. Materials should be stored in the environment in which they are to be fixed at least 48 hours prior to fixing. Do not place large quantities of materials such as particleboard, timber or plasterboard on top of laid flooring system as any additional loading may cause damage and affect warranties. If in doubt refer to manufacturers manual for recommendations.

Preparation

The building must be weather proof and all materials must have reached their recommended moisture content before commencing installation of the flooring system. All joints and air paths between concrete units and at perimeter walls must be carefully and thoroughly grouted for effective performance of acoustic floors. Components exposed to wet conditions such as ingress of rain or plumbing leaks should be discarded and replaced.

Dryness of Concrete and Timber

Excessive moisture from cast in situ slabs and screeds which have not dried out can have adverse effects on flooring materials and timber components. Therefore “it is reasonable to recommend that the concrete be considered dry when the relative humidity falls to 75% or less” (when tested by use of a hygrometer). Where the dryness of concrete cannot be guaranteed it is recommended that a vapour barrier is installed that complies with the appropriate code of practice and building regulations.

Services

The provision of access to services is most successful if the location of services are identified on as built drawings. Services should be kept at least 150mm away from walls to allow space for perimeter support Battens. Any service penetration and detailing must be pre-approved by Batten & Cradle™.

Batten & Cradle™ Flooring Systems Recommended Installation Manual for installers

Design Recommendations

Partitions

Most lightweight timber or metal stud partitions may be constructed directly on the floating floor. Internal load bearing Partitions should be erected from the sub-floor and not on top of the floating floor. All partitions must be approved by the designer prior to their installation locations.

Access Panels

Batten & Cradle™ Flooring Systems are ideal for providing partial access to services. Access panels should be square edged and supported along all edges by Support Battens. The panels should be screwed to the battens without bridging the resilient layer.

Ceramic Tiles

As acoustic floors are designed to deflect vertically in order to reduce impact sound there are inherent risks in laying ceramic tiles on top of floating floors. However the risks can be significantly reduced by good detailing and the use of flexible adhesives. Ceramic tiles have been successfully laid on Batten Cradle System.

Support Batten & Cradle™ Centres

Support Battens and Cradles must be laid in accordance with centres specified.

Cradles and Support Battens

To ensure consistent levels throughout the building, commence in corridor areas proceeding to rooms. In each area work to a datum using packers and elevating blocks to overcome low areas or cambers. Ensure that each Cradle is sitting on a level, flat spot. Cradles should not rock or lie at an angle. Set out the Cradles and Support Battens where needed around the perimeter of the room so that the Support Battens are approximately 50mm from perimeter walls. Then lay the remainder of Support Battens levelling with the packers as required. Where Support Battens meet, the Cradle should be positioned so that it equally supports both ends. When laying alternate rows of Support Battens, commence with a half-length so that the joints are staggered.

Batten & Cradle™ Flooring Systems Recommended Installation Manual for installers

Services

The 20mm Resilient Cradle Support will not always allow for services to run underneath the Support Batten. In this instance cut the Support Battens and place approximately 8mm either side of the pipe. Fully support the Battens with additional Cradles. Additional noggins may also be required to properly support the specified floor.

Do not notch Support Battens

If it is intended that services run under the Support Battens a deeper Resilient Cradle Support should be specified and adequate clearance provided beneath the Support Batten. In acoustic systems ensure that gaps where services come through the flooring are sealed to prevent airborne sound leakage.

Packing

In order to achieve a level floor, place the correct combination of packers within the shoulders of the Cradle plate to a maximum of 5mm from the top shoulder of the cradle. If more packing is needed than what is achievable within the shoulders, a 100 x 100mm approved packer may be placed under the cradle. If two or more packers are used we recommend using a light adhesive between each packer. We recommend all packers be glued with a suitable construction adhesive between each other and the batten.

Perimeters

Ensure that there is an expansion gap of at least 5mm to 8mm between the edges of the flooring and at the perimeter walls. This gap must also be maintained at doorframes and filled with acoustic sealant.

Thresholds

A Support Batten on Cradles should be placed across the threshold for additional support. The flooring type should be configured so as to ensure no but joints are present.

Installation of flooring products

When laying flooring products such as carpet, vinyl and tiles on top of the Batten & Cradle™ Flooring System, always refer to the manufacturers instruction on how to install their products.

See details in:
James Hardie Brochure
Laminex Brochure
Futurebuild Brochure

Batten & Cradle™ Flooring Systems Recommended Installation Manual for installers

Additional Components - (Acoustic Systems Only)

Batten & Cradle™ Acoustic Insulation

If specified, lay acoustic insulation between the Cradles over the entire floor area. The edges of insulation should be turned up at the perimeter walls. The same method will apply if thermal insulation is being used on a ground floor application.

The Batten & Cradle™ System

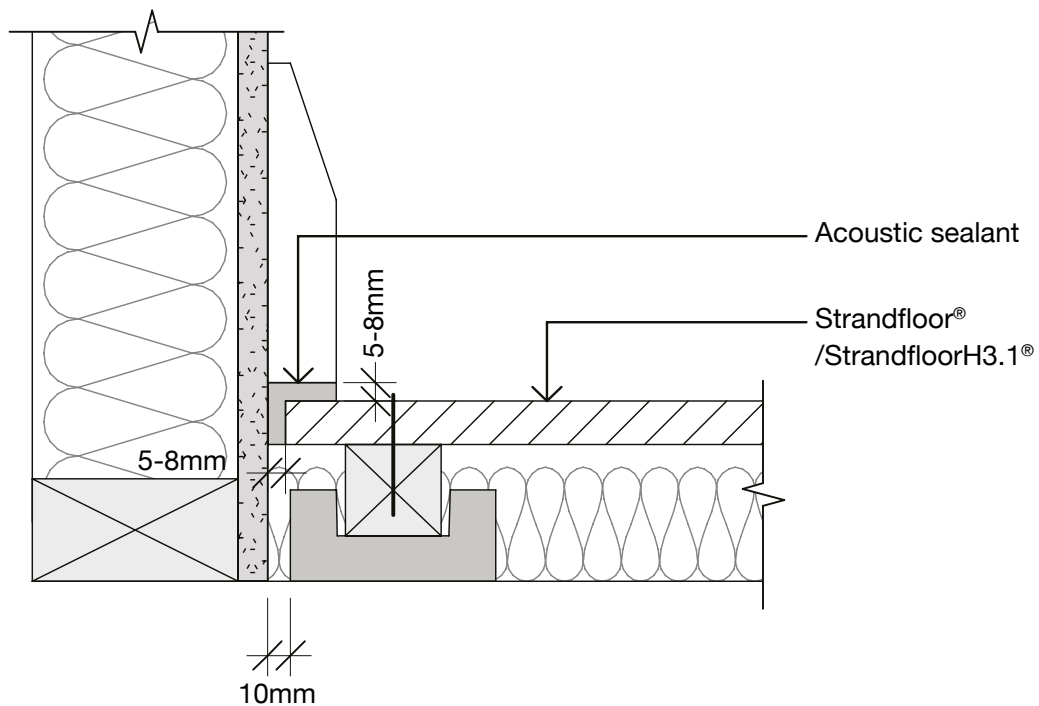

Batten & Cradle™ Flooring Systems Recommended Installation Manual for installers

Strandfloor® Joist Layer Installation



Batten & Cradle™ Flooring System set up

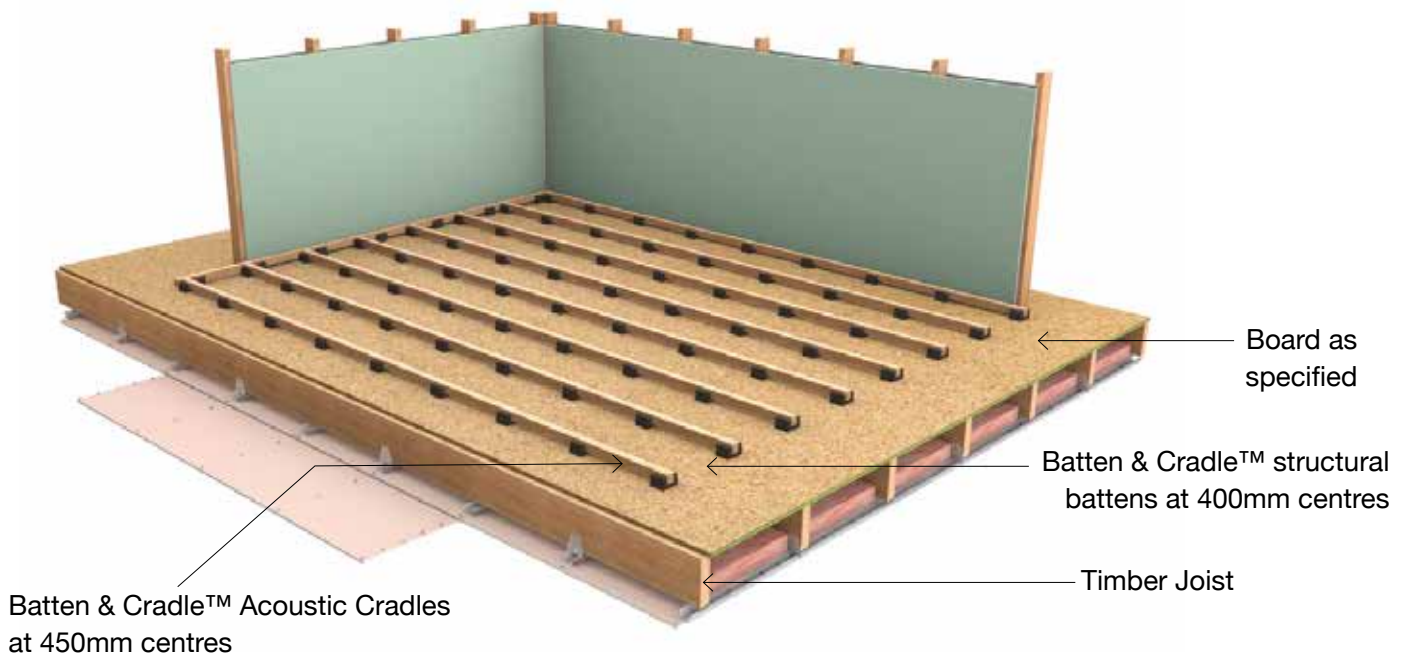

Batten & Cradle™ Flooring Systems Recommended Installation Manual for installers

Insulation, density of 9.6kgs /m³ minimum

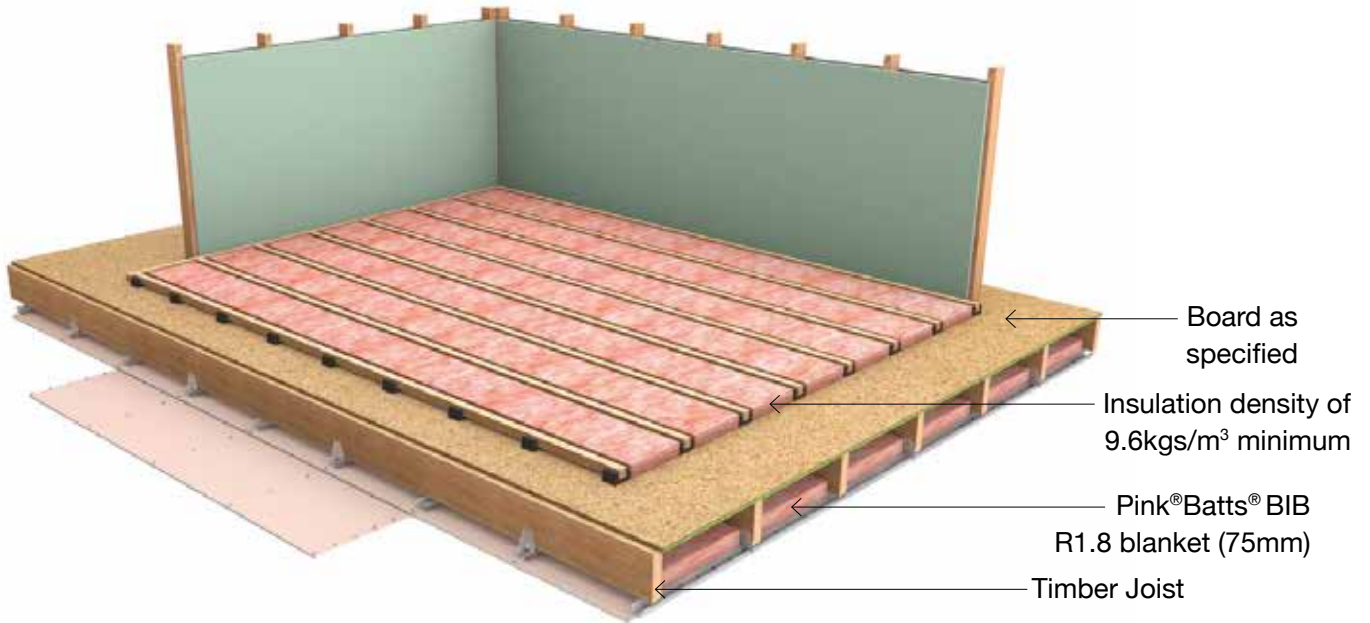

Strandfloor® second layer installation

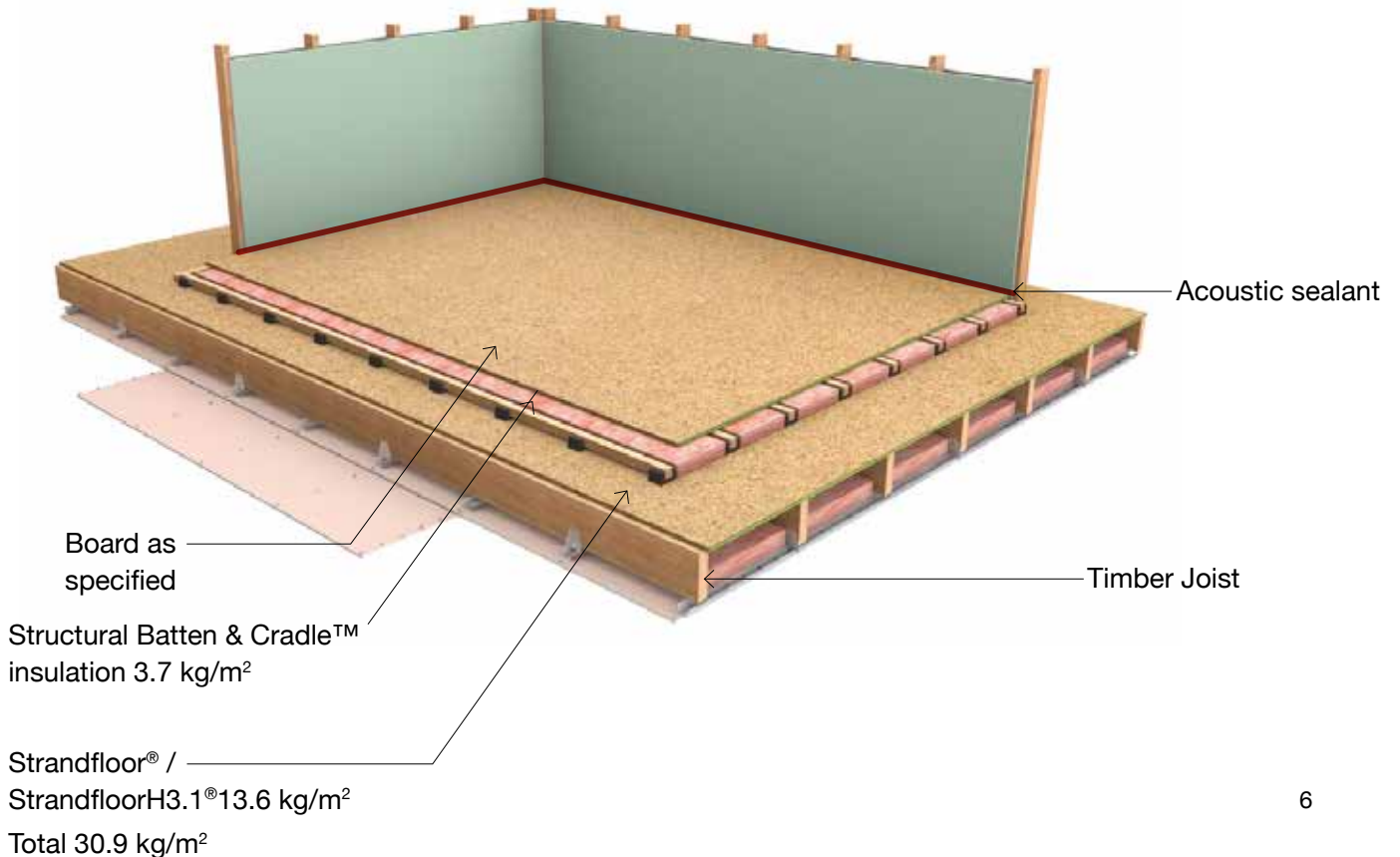



Conference of the Acoustical Society of New Zealand

Tapping machine and impact ball laboratory testing of CLT slab systems with and without floating floors and ceilings

Thomas Warren ⁽¹⁾ and Tim Beresford ⁽¹⁾

(1) Norman Disney & Young, 29 Customs Street West, Auckland
t.warren@ndy.com, t.beresford@ndy.com

ABSTRACT

Cross Laminated Timber (CLT) is a modern building material which is gaining increasing application in New Zealand and Australian apartment developments as a natural and sustainable building material. Additional floor coverings, floating floors, and/or ceilings are typically added to CLT floor systems in order to improve the airborne and impact sound insulation. When compared to concrete buildings, low frequency impact noise can be more pronounced in CLT due to the lower mass of this material. The Building Codes of both New Zealand (NZBC) and Australia (BCA) do not specifically assess low frequency impact noise (below 100 Hz). This paper publishes the results of recent laboratory impact noise testing of 126 mm and 210 mm CLT slabs with and without rubber isolated raised floor systems, with different floor surfaces, and with and without suspended ceilings. The published results include standardised tapping machine testing (IIC and $L_{n,w}$) as well as impact ball testing to assess the low frequency performance. Results of the laboratory testing are compared to previously published in-situ results for similar floor systems. The results of impact ball testing undertaken in the laboratory are compared to published criteria from Korean and Japan to assess the performance of the NZBC-compliant CLT constructions (achieving IIC 55) against international guidance (heavy impact source criteria).

INTRODUCTION

Cross Laminated Timber (CLT) is a modern building material produced by glue-laminating planks of timber together and layering these in perpendicular directions to form a highly rigid, multi-layered panel. Prefabrication of CLT panels can provide an advantage over concrete structural elements due to reduced construction times on site. CLT panels can also be selected as a more sustainable option compared to concrete.

Compared to concrete, however, CLT has relatively low surface mass. The thickness of CLT in apartments is typically 100-210 mm, with a surface mass of between 40 and 100 kg/m². This compares to a typical concrete apartment floor with a surface mass of 240-480 kg/m². The CLT is however heavier than the plywood or particle board typically found as the structural flooring membrane of lightweight timber joist construction methods.

In general, lower-mass construction methods results in increased impact noise at the lower frequencies.

In New Zealand there is increasing use of CLT in residential developments, where a combination of a floating floor and suspended ceiling are used to meet the requirements of the Building Code.

This paper presents the results of several configurations of Red Stag CLT floor constructions which have recently been tested in the Acoustics Testing Services laboratory at the University of Auckland. Data are reported below the 100 Hz lower end of the IIC assessment range to allow review of the low frequency performance of these systems. Results are also reported using a heavy impact source as $L_{iA,Fmax}$ (or $L_{iA,Fmax,V,T}$, see below).

TESTED FLOOR TYPES

The tested floor systems included CLT floor slabs with and without a floating floor above and ceiling below.

The general configuration is shown in Figure 1.

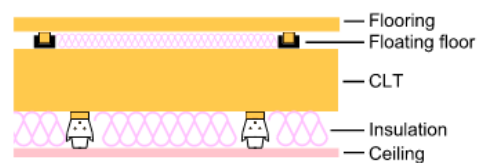

Figure 1: Test configuration.

The tested raised floor surfaces included:

- 20 mm high density reconstituted wood panel with nominal surface density 13.6 kg/m² (Laminex Strandfloor); or
- 20 mm particle board with or without 6 mm thick 8.6 kg/m² fibre cement sheet (Hardie Flex) on top; or
- 19 mm fibre cement sheets with nominal surface density 24.5 kg/m² (James Hardie Secura).

The floating floor system was a Batten and Cradle system comprised of 40 (W) x 42 (H) mm LVL timber Quiet Batters at 400 mm centres supported in AcoustiFlor chopped rubber Cradles, nominally 20 mm deep and spaced at 450 mm centres. The raised floor cavity was filled with 50 mm thick R1.2 glass fibre insulation (Pink Batts).

The CLT was either 126 mm thick 3-ply or 210 mm thick 5-ply CLT panels (Red Stag).

Conference of the Acoustical Society of New Zealand

The ceiling framing consisted of 35 mm Rondo furring channels spaced at 600 mm centres in GIB Quiet clips spaced at 120 mm centres. The GIB Quiet Clips were screw fixed to timber block mounts to allow installation to the underside of the CLT, with a ceiling cavity depth of 130 mm. The ceiling cavity included 90 mm thick R2.2 glass fibre insulation (Pink Batts).

The ceiling lining was up to two layers of 13 mm fire rated plasterboard ceiling, nominal surface weight 11 kg/m² per layer (GIB Fyreline).

The tested systems are described in Table 1 below.

Table 1. Description of tested systems.

Test ID	Floating Flooring	CLT	Ceiling
1	None	126 mm	None
2	20 mm Strandfloor	126 mm	None
3	20 mm Strandfloor	126 mm	1 x layer plasterboard
4	20 mm Strandfloor	126 mm	2 x layer plasterboard
5	20 mm particle board	126 mm	2 x layer plasterboard
6	2 x layers 20 mm particle board	126 mm	2 x layer plasterboard
7	6 mm Hardyflex on 20 mm particle board	126 mm	2 x layer plasterboard
8	19 mm fibre cement	126 mm	2 x layer plasterboard
9	None	210 mm	None
10	20 mm Strandfloor	210 mm	None
11	20 mm Strandfloor	210 mm	1 x layer plasterboard
12	20 mm Strandfloor	210 mm	2 x layer plasterboard
13	None	210 mm	2 x layer plasterboard

ASSESSMENT CRITERIA AND METHODOLOGY

The floor constructions were each assessed against the impact sound insulation performance metrics found in the New Zealand Building Code (NZBC) and Building Code of Australia (BCA). Further to the Building Code metrics, assessing the low-frequency performance of these floors was of particular interest. Because the standard tapping machine impact tests described in the ISO and ASTM standards (referred to in the NZBC and BCA) are unsuitable for assessing very low-frequency floor impact performance, a heavy impact source was used in addition to a standard tapping machine. The heavy impact source

was a standardised rubber ball drop as per JIS A 1418-2: 2000.

The assessment methods used were as follows:

- IIC: Impact Insulation Class determined according to ASTM E 492: 1990 and ASTM E 989: 1989 (NZBC G6 1992 requirement)
- L_{n,w}: Weighted standardised impact sound pressure level determined according to ISO 717.2: 2004 (BCA Part F5 2019 requirement)
- L_{iA,Fmax,V,T}¹: Maximum A-weighted floor impact sound level (1/3 octave bands 50 Hz to 630 Hz) determined according to ISO 10140-3: 2021 using the rubber ball drop method and ISO 717-2: 2020.

The minimum Building Code on-site performance requirements for apartment floors are as follows:

- NZBC impact: Not less than IIC 55
- BCA impact: Not greater than L_{n,w} 62dB
- No heavy impact criteria under either Building Code

RESULTS

The single figure results for each of the assessed metrics are shown in Table 2. Spectral results are shown in Figure 2 and Figure 3. Not all tests included the heavy impact ball drop.

Table 2. Single figure results.

Test ID	IIC	L _{n,w}	L _{iA,Fmax,V,T}
1	20	90	76
2	41	69	70
3	47	54	64
4	56	50	-
5	55	51	60
6*	59	47	-
7*	55	50	-
8	55	49	60
9	24	86	72
10	44	66	68
11	53	51	61
12	60	46	58
13	54	57	-

*These tests had two impact positions only

¹As per ISO 10140-3: 2021, corrections for volume and reverberation time (subscript V,T) of the laboratory have been applied for better comparison with results from other laboratories and actual buildings.

Conference of the Acoustical Society of New Zealand

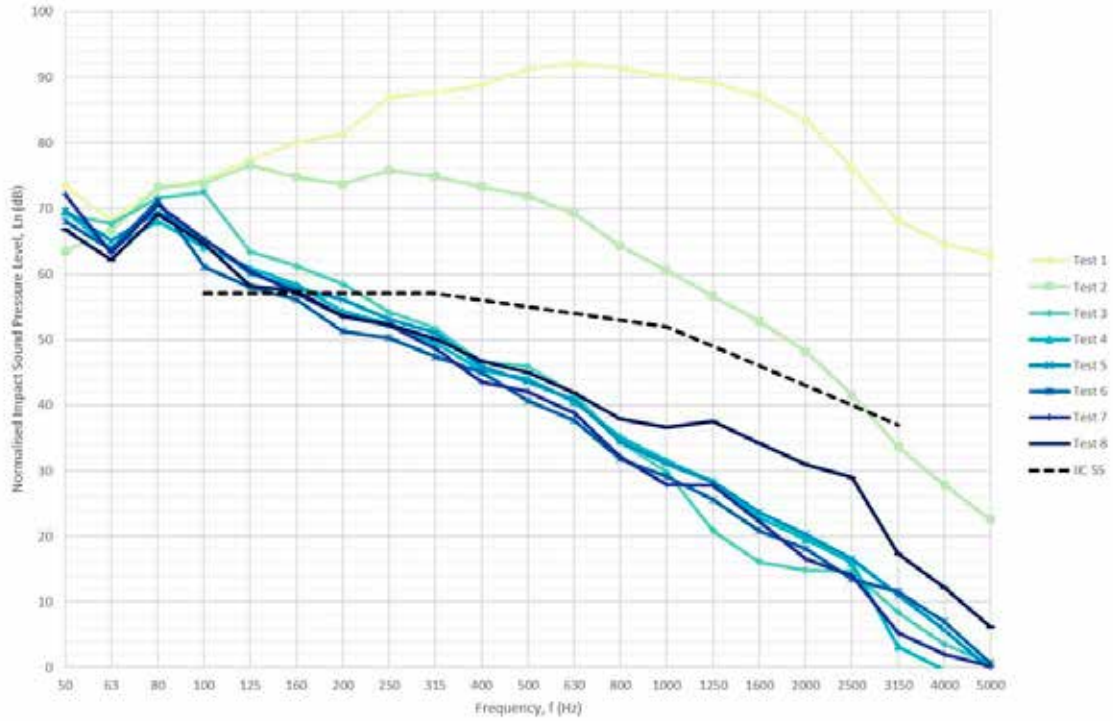

Figure 2: 126 mm CLT results.

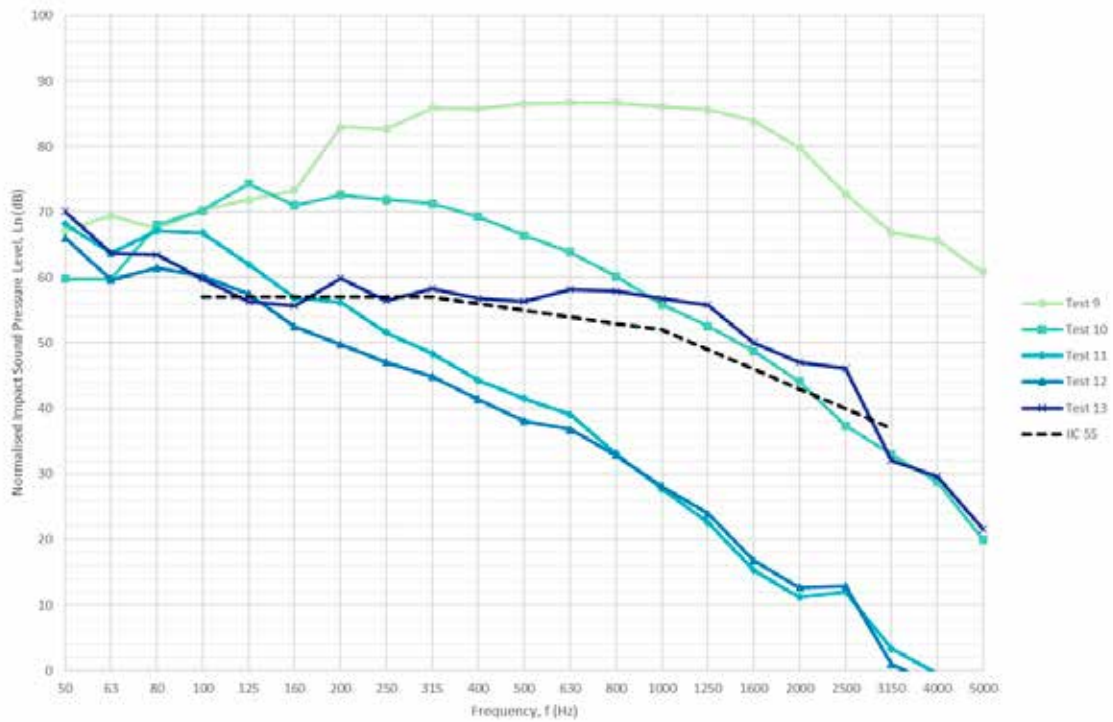

Figure 3: 210mm CLT results.

31st of October – 2nd of November 2022, Wellington

Conference of the Acoustical Society of New Zealand

DISCUSSION

New Zealand Building Code Compliance

All of the systems with both a floating floor and a two layer ceiling complied with the IIC requirements of the NZBC. None of the systems with either no floating floor or fewer than two ceiling linings complied with the IIC requirements of the NZBC. This applied for both CLT slab thicknesses tested.

The implication of this is that in order to meet the NZBC with relatively small (130 mm) ceiling cavities both a floating floor and a double layer ceiling is required, with insulation to both cavities.

Building Code of Australia Compliance

All systems which met the NZBC IIC requirements also met the BCA $L_{n,w}$ requirements of not more than 62. In addition, the systems with a floating floor and a single layer ceiling, and the system with no floating floor on 210 mm CLT with a two layer ceiling complied with the BCA $L_{n,w}$ requirements.

The constructions which complied with the BCA but not the NZBC can be attributed to the relative lenience of the BCA compared to the NZBC for impact sound insulation.

Results from in-situ testing of similar CLT floors

It is useful to compare the results from the laboratory testing to previously reported FIIC results tested on two sites with similar floor systems but a deeper ceiling cavity, both published by Beresford and Chen in [1] and [2] respectively.

Both of these site test configurations were the same:

- 20 mm Strandfloor
- Batten and Cradle system as described for the recent laboratory testing earlier in this paper, except that the insulation was 50 mm polyester, 10 kg/m³.
- 105 mm CLT
- Suspended 13mm standard plasterboard ceiling (9 kg/m²) on resilient clips with 60 mm polyester insulation, 10 kg/m³. Nominal ceiling cavity depth 390 mm.

The results of these tests are shown in Table 2 below, where the test from [1] is shown as Test A, and the test from [2] is shown as Test B.

Table 2. Single figure results.

Test ID	FIIC	$L_{n,Tw}$	$L_{iA,Fmax(V,T)}$
3	47	54	64 (V,T)
A	60	47	56
B	56	47	57

The spectra are shown in Figure 4 below.

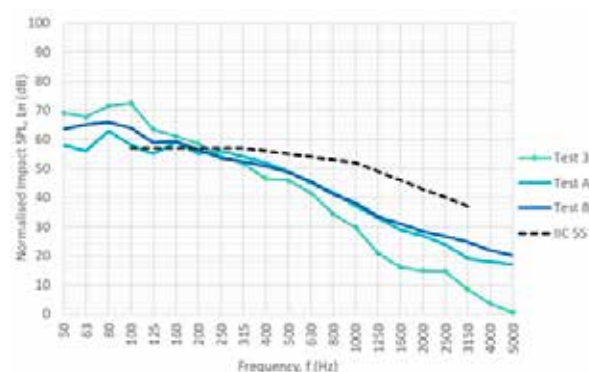

Figure 4: IIC and FIIC comparison with different ceiling cavities.

Comparison of IIC and FIIC results with varied ceiling cavity

In the laboratory testing with a consistent 130mm ceiling cavity, neither the 105 mm CLT (Test 3) nor the 210 mm CLT (Test 11) achieved the NZBC impact noise requirement of IIC 55 with a single layer plasterboard ceiling.

We have compared this to the two on-site FIIC tests (Tests A and B) which achieved FIIC 60 and 56 respectively with a single layer standard plasterboard ceiling, meeting both the FIIC 50 requirement of the NZBC and the IIC 55 requirement (albeit tested in the field).

The main difference between Test 1 and Tests A and B is the ceiling installation, where Test 1 includes Quiet Clips and a 130 mm cavity and Tests A and B include resilient clips with a suspended 390 mm ceiling cavity.

Comparing the low frequency performance of all three systems shown in Figure 3, Test 3 shows a peak in the 100 Hz 1/3 octave band. This peak falls within the standard assessment range for the IIC rating (100-3150 Hz) and influences the result. Tests A and B show the biggest peak in the 80 Hz 1/3 octave band, which sits outside the assessment range for the IIC rating.

This shift can be attributed to a lower mass-air-mass resonance in the deeper ceiling cavity, resulting in an increase in measured impact noise performance with the IIC standard. It is plausible that for Test 3, the resonances for the floor and ceiling cavities are at similar frequencies, contributing to the peak seen in the results.

We can further compare the performance between Test 3 (one layer ceiling) and Test 4 (two layer ceiling) which were otherwise identical. The spectrum for Test 4 shows a peak in the 80 Hz 1/3 octave band (as do tests 5 through 8, each of which has a double layer ceiling). In this case the doubling of the mass of the ceiling has shifted the mass-air-mass resonance outside the IIC assessment range and provides a significant improvement in the IIC result.

Conference of the Acoustical Society of New Zealand

Heavy impact ball drop results

Of the samples which were tested with a heavy impact source, the best result was from Test 12 at 58 dB $L_{iA,Fmax,V,T}$.

There are no mandatory or suggested criteria in Australia or New Zealand for heavy impact sound insulation. International research in recent years has included subjective studies using different impact sources and rating methods, with a particular focus on heavy impact sources by researchers in Korea and Japan. Existing classification systems in Korea and Japan are not directly comparable to the ISO $L_{iA,Fmax}$ rating, because the Korean and Japanese minimum requirements have used an inverse A-weighting maximum deviation method rather than the simple A-weighted L_{max} approach of the ISO $L_{iA,Fmax}$.

Some recent studies have proposed minimum acceptable $L_{iA,Fmax}$ heavy impact sound insulation criteria. Jeon and Oh [3] suggest an acceptability limit of 50 dB $L_{iA,Fmax}$. Sato and Yoshimura [4] also refer to a proposed “acceptable limit for usual use” of 50 dB $L_{iA,Fmax}$. Jeong [5] undertook subjective testing of rubber ball impact sound on different structures, for different domestic tasks, and with different background noise, and indicated different minimum standards for timber constructions of 51-57 dB $L_{iA,Fmax}$.

Ongoing research in this area does not appear to have reached a consensus regarding acceptable impact sound insulation from heavy impacts in timber buildings. It is interesting to observe that the NZBC-compliant CLT constructions adopted in New Zealand with both a floating floor and a suspended ceiling are achieving $L_{iA,Fmax}$ levels several dB above published suggested acceptable levels. If minimum performance standards are to be adopted in New Zealand in the future, it would be useful to assess the subjective experience of occupants living in CLT apartment buildings and compare this to subjective research undertaken internationally.

CONCLUSIONS

Impact noise test results have been presented for a range of CLT floor constructions.

Lightweight floating floors combined with a suspended ceiling are effective methods of achieving compliance with NZBC and BCA requirements for CLT floor-ceiling systems.

With relatively small (130 mm) ceiling cavities, a double layer ceiling is required to achieve NZBC impact noise requirements when combined with a lightweight floating floor on CLT. Some evidence from on-site testing with deeper cavities indicates that with a 390 mm or greater cavity, a single layer ceiling may be sufficient when combined with a lightweight floating floor on CLT.

ACKNOWLEDGMENTS

We gratefully acknowledge the companies that funded and supported the testing described in this paper, including Red Stag, Batten and Cradle Flooring Systems, Winstone Wallboards, and Laminex; and the University of Auckland’s Acoustics Testing Service for undertaking the testing.

REFERENCES

- [1] T. Beresford and J. Chen, “Floor airborne and impact sound insulation performance of cross laminated timber vs. timber joist and concrete systems,” in Proc. ACOUSTICS 2018, Auckland New Zealand, 7-9 Nov. 2018.
- [2] T. Beresford and J. Chen, “The effects of acoustic flanking degradation on apartment floors with exposed cross laminated timber walls,” in Proc. 24th Biennial Conf. ASNZ, Auckland New Zealand, 12-14 Nov. 2018.
- [3] J. Y. Jeon and S. M. Oh, “Psychoacoustical evaluation of heavyweight floor impact sounds in apartment buildings,” in Proc. Inter-noise 2014, Melbourne Australia, 16-19 Nov. 2014.
- [4] H. Sato and J. Yoshimura, “Classification scheme of floor impact sounds with the standard rubber ball in dwellings,” in Proc. Inter-noise 2014, Melbourne Australia, 16-19 Nov. 2014.
- [5] J. Jeong, “Background noise, noise sensitivity, and attitudes towards neighbours, and a subjective experiment using a rubber ball impact sound,” Int. J. Environ. Res. Public Health, vol. 18, no. 7569, Jul. 2021.



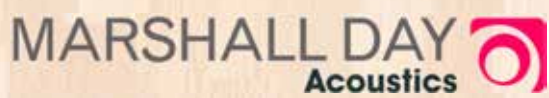

OPINION ON IMPACT INSULATION RATING OF
BATTEN & CRADLE™ FLOORING SYSTEMS WITH
STEEL BATTENS

Rp 001 201608av | 5 August 2016

Project: **OPINION ON IMPACT INSULATION RATING OF BATTEN & CRADLE™
FLOORING SYSTEMS WITH STEEL BATTENS**

Prepared for: **Batten & Cradle™ Acoustic Flooring Ltd
PO Box 5074
New Plymouth 4343**

Attention: **Peter Huston**

Report No.: **Rp 001 01 201608av**

Disclaimer

Reports produced by Marshall Day Acoustics Limited are based on a specific scope, conditions and limitations, as agreed between Marshall Day Acoustics and the Client. Information and/or report(s) prepared by Marshall Day Acoustics may not be suitable for uses other than the specific project. No parties other than the Client should use any information and/or report(s) without first conferring with Marshall Day Acoustics.

The advice given herein is for acoustic purposes only. Relevant authorities and experts should be consulted with regard to compliance with regulations or requirements governing areas other than acoustics.

Copyright

The concepts and information contained in this document are the property of Marshall Day Acoustics Limited. Use or copying of this document in whole or in part without the written permission of Marshall Day Acoustics constitutes an infringement of copyright. Information shall not be assigned to a third party without prior consent.

Document Control

Status:	Rev:	Comments	Date:	Author:	Reviewer:
Draft			4 August 2016	K O Ballagh	M S Dunn

TABLE OF CONTENTS

1.0	INTRODUCTION	4
2.0	CONSTRUCTION	4
2.1	Floor/Ceiling construction.....	4
3.0	TEST RESULTS.....	4
4.0	CALCULATIONS	5
5.0	OPINION	5
6.0	LIMITATIONS	5

1.0 INTRODUCTION

Marshall Day Acoustics was asked to provide an opinion on the Impact Insulation Class (IIC) rating that would be achieved by the Batten and Cradle™ flooring system installed on a typical timber joist floor/ceiling construction. This opinion is based on laboratory tests of the floor system on a light weight timber floor and previous tests and computer prediction models of floor and ceiling combinations without the flooring overlay.

2.0 CONSTRUCTION

2.1 Floor/Ceiling construction

The floor assembly for which the opinion is provided is as follows:

Batten and Cradle™ – with Secura Flooring

- 19 mm Secura™ flooring system, screw fixed at 600 mm centres to
- Batten & Cradle Steel Battens™ (40 x 42 mm x 1.2mm roll formed batten) spaced at 400mm centres on
- Acousticflor™ rubber cradles spaced at 450mm centres
- 60 mm floor cavity containing an acoustic blanket of minimum 50 mm thickness and of minimum density 10 kg/m³ (minimum flow resistivity 1400 Rayl/m).

Floor/Ceiling Construction

- 19 mm Secura™ flooring system fixed at 600 mm centres to minimum 190 x 45 mm timber or LVL joists, or minimum 200mm deep Posi-STRUT™ joists
- Either:
 - 2 layers of 13 mm Gib® Fyreline, or
 - 1 x 16mm Gib® Fyreline

Fixed to either:

- USG ScrewFix steel frame suspension system comprising 2.5 mm wire hangers at 1200 mm centres supporting DJ38 strongback channels spaced at 600 mm centres maximum, installed in accordance with manufacturers recommendations, or
- Gib® Quiet Clips® or ST001 Acoustic Mounts fixed to the joists and holding Gib Rondo 308 battens, installed in accordance with manufacturer's recommendation.
- The perimeter of the ceiling is sealed with flexible acoustic sealant such as Gib® Soundseal.
- An acoustic blanket of minimum 75 mm thickness and of minimum density 10 kg/m³ is placed in the ceiling cavity (minimum flow resistivity 1400 Rayl/m)

3.0 TEST RESULTS

The impact and airborne sound insulation of a light weight floor with and without the Batten and Cradle™ floor covering was tested by the University of Auckland Acoustics Testing Service (Test Reports T1612-1 and T1612-2 March, 2016). The difference in impact sound and airborne sound transmission between the light weight floor alone and the light weight floor with the Batten and Cradle system was able to be determined from these tests.

4.0 CALCULATIONS

The sound transmission loss and impact sound insulation of the floor/ceiling construction was calculated by using INSUL software to predict the base performance of the assembly with no floor covering. The measured improvement for the Batten and Cradle™ system on a lightweight floor was then added to the base performance to estimate the performance of the floor/ceiling with a Batten and Cradle system over top.

5.0 OPINION

The estimated laboratory performance of the floor described in Section 2 is given in the table below:

Table 1: Estimated Sound Transmission Loss

Partition	Description	STC	Rw	IIC	L _{nTw}
	Secura flooring on Batten and Cradle™ system on Secura flooring fixed to timber, LVL or Posi-STRUT joists with 2 x 13mm Gib Fyreline ceiling with 75mm Pink Batts Silencer blanket in cavity	>68	>68	59	45
	Secura flooring on Batten and Cradle™ system on Secura flooring fixed to timber, LVL or Posi-STRUT joists with 1x 16mm Gib Fyreline ceiling with 75mm Pink Batts Silencer blanket in cavity	>68	>68	60	47

Note: Airborne values have been limited to not more than STC 68 as flanking transmission will limit on site performance in most situations.

6.0 LIMITATIONS

The above opinions are an estimate of the laboratory performance not the field performance. The estimate is based on the original laboratory tests, the materials as currently manufactured and the construction details set out above. Readers are advised to check that this opinion has not been revised by a later issue. The estimate is expected to be in error by less than 3 IIC/dB.

Note:

This opinion may be reproduced in full but not in part without the written consent of Marshall Day Acoustics Ltd.



Opinion on Impact Insulation Rating of Batten & Cradle™ Flooring Systems

April 2014



Project: **Opinion on Impact Insulation Rating of Batten & Cradle™
Flooring System on a lightweight floor**

Prepared for: **Batten & Cradle™ Acoustic Flooring Ltd
PO Box 5074
New Plymouth 4343**

Report No.: **Rp001 r01 201404ar**

Document control

Status:	Issue:	Date:	Prepared by:	Reviewed by:
Current	R00	8 April 2014	K O Ballagh	M S Dunn
Final	R01	17 April	K O Ballagh	M S Dunn

Note: This document may be reproduced in full but not in part without the written consent of Marshall Day Acoustics Limited

TABLE OF CONTENTS

1.0	INTRODUCTION	4
2.0	CONSTRUCTION	4
2.1	Floor/Ceiling construction.....	4
	Floor/Ceiling Construction	4
3.0	TEST RESULTS.....	5
4.0	OPINION	5
7.0	LIMITATIONS.....	5
8.0	INTERPRETATION.....	6
8.1	Rating Systems	6
8.1.1	NZ Building Code.....	6
8.1.2	Proposed Building Code	6
8.2	Field Performance.....	6

1.0 INTRODUCTION

Marshall Day Acoustics was asked to provide an opinion on the Impact Insulation Class (IIC) rating that would be achieved by the Batten and Cradle™ flooring system installed on a typical timber joist floor/ceiling construction. This opinion is based on laboratory tests of the floor system on a light weight timber floor and previous tests and computer prediction models of floor and ceiling combinations without the flooring overlay.

2.0 CONSTRUCTION

2.1 Floor/Ceiling construction

The floor assembly for which the opinion is provided is as follows:

Batten and Cradle™ – with Scyon Secura Flooring

- 19 mm Scyon® Secura™ flooring system, screw fixed at 200 mm centres to
- Dressed 42 mm x 42 mm finger joint timber battens spaced at 400 mm centres on
- AC-20 rubber cradles spaced at 450 mm centres
- 65 mm floor cavity containing 75 mm Pink Batts Silencer

Floor/Ceiling Construction

- 19 mm Scyon® Secura™ flooring system fixed at 200 mm centres to minimum 190 x 45 mm timber or LVL joists, or minimum 200mm deep Posi-STRUT™ joists
- Either:
 - 2 layers of 13 mm Gib® Fyreline, or
 - 1 x 16mm Gib® Fyreline

Fixed to either:

- USG ScrewFix steel frame suspension system comprising 2.5 mm wire hangers at 1200 mm centres supporting DJ38 strongback channels spaced at 600 mm centres maximum, installed in accordance with manufacturers recommendations, or
- Gib® Quiet Clips® or ST001 Acoustic Mounts fixed to the joists and holding Gib Rondo 308 battens, installed in accordance with manufacturer's recommendation.
- The perimeter of the ceiling is sealed with flexible acoustic sealant such as Gib® Soundseal.

Note: This document may be reproduced in full but not in part without the written consent of Marshall Day Acoustics Limited

- An acoustic blanket of minimum 75 mm thickness and of minimum density 10 kg/m³ is placed in the ceiling cavity (minimum flow resistivity 1400 Rayl/m)

3.0 TEST RESULTS

The impact and airborne sound insulation of a light weight floor with and without the Batten and Cradle™ floor covering was tested by the University of Auckland Acoustics Testing Service (Test Reports T1405-1 and T1405-2 April 2014). The difference in impact sound and airborne sound transmission between the light weight floor alone and the light weight floor with the Batten and Cradle system was able to be determined from these tests.

4.0

CALCULATIONS

The sound transmission loss and impact sound insulation of the floor/ceiling construction was calculated by using INSUL software to predict the base performance of the assembly with no floor covering. The measured improvement for the Batten and Cradle™ system on a lightweight floor was then added to the base performance to estimate the performance of the floor/ceiling with a Batten and Cradle™ system over top.

5.0 OPINION

The estimated laboratory performance of the floor described in Section 2 is given in the table below:

Table 1: Estimated Sound Transmission Loss

Partition	Description	STC	Rw	IIC	L _{nTw}
	Scyon Secura flooring on Batten and Cradle™ system on Scyon Secura flooring fixed to timber, LVL or Posi-STRUT joists with 2 x 13mm Gib Fyreline ceiling with 75mm Pink Batts Silencer blanket in cavity	68	68	55	48
	Scyon Secura flooring on Batten and Cradle™ system on Scyon Secura flooring fixed to timber, LVL or Posi-STRUT joists with 1x 16mm Gib Fyreline ceiling with 75mm Pink Batts Silencer blanket in cavity	65	64	53	50

6.0 LIMITATIONS

The above opinions are an estimate of the laboratory performance not the field performance. The estimate is based on the original laboratory tests, the materials as currently manufactured and the construction details set out above. Readers are advised to

Note: This document may be reproduced in full but not in part without the written consent of Marshall Day Acoustics Limited

check that this opinion has not been revised by a later issue. The estimate is expected to be in error by less than 3 IIC/dB.

7.0 INTERPRETATION

7.1 Rating Systems

7.1.1 NZ Building Code

The Impact Insulation Class (IIC) of a floor/ceiling system reflects its ability to prevent impact on its surface from being transmitted as structure-borne vibration and radiating as air-borne noise. Higher IIC ratings indicate that less noise is transmitted to the room below. The existing NZ Building Code requires that new floors have a laboratory rating of IIC 55 or higher. In addition the floor must be constructed to ensure the on-site Field Impact Insulation Class (IIC) is no less than FIIC 50.

7.1.2 Proposed Building Code

The proposed NZ Building Code (G6) requires a Standardised Impact Sound Pressure Level ($L'_{nT,w}$) of 57 dB or less between habitable spaces. This is a rating for the in-situ impact sound measured rather than a laboratory floor performance rating. The lower the $L'_{nT,w}$ the lower the impact noise and correspondingly the higher the performance of the floor.

The calculation of $L'_{nT,w}$ from a laboratory measurement requires an estimation of room size. The results presented in the table above have been based on a receiving room size of 50 m³. It should be noted that the figures would not be appropriate for rooms considerably larger or smaller than 50 m³ and calculation of alternative allowances would be required.

The performance estimates have been made considering only vertical transmission of impact borne sound. It should also be noted that whilst $L'_{nT,w}$ describes a field measurement in this instance, no allowance has been made for on-site flanking transmission and no consideration has been given to horizontal transmission. However flanking impact sound should be controlled as the top floor surface is not rigidly connected to the floor structure.

7.2 Field Performance

To ensure the on-site measurements are similar to the laboratory results the products must be installed and constructed in a similar way to the laboratory tests and any substitution of materials must be approved by the project's Acoustic Consultant. In addition, potential flanking paths, such as external walls, need to be considered and mitigated against.

The use of materials other than those referred to in Section 2 or the introduction of additional materials (e.g. underfloor heating), including the lack of any perimeter isolation, can significantly affect the field performance rating (i.e. may result in a failure in

Note: This document may be reproduced in full but not in part without the written consent of Marshall Day Acoustics Limited

accordance with the NZ Building Code). MDA strongly recommend trial performance testing on site before proceeding with full installation.

Note:

This opinion may be reproduced in full but not in part without the written consent of Marshall Day Associates.



**Opinion on Impact Insulation Rating of Scyon® Secura™
Interior Flooring on Batten & Cradle™ Flooring Systems**

June 2013



Project: **Opinion on Impact Insulation Rating of Scyon® Secura™
Interior Flooring on Batten & Cradle™ Flooring**

Prepared for: **James Hardie Ltd
PO Box 12070
Auckland 1642**

and

**Batten & Cradle™ Acoustic Flooring Ltd
PO Box 5074
New Plymouth 4343**

Report No.: **RP001 201305cu**

Disclaimer

Reports produced by Marshall Day Acoustics Limited are prepared based on the Client's objective and are based on a specific scope, conditions and limitations, as agreed between Marshall Day Acoustics and the Client. Information and/or report(s) prepared by Marshall Day Acoustics may not be suitable for uses other than the original intended objective. No parties other than the Client should use any information and/or report(s) without first conferring with Marshall Day Acoustics.

Copyright

The concepts and information contained in this document are the property of Marshall Day Acoustics Limited. Use or copying of this document in whole or in part without the written permission of Marshall Day Acoustics constitutes an infringement of copyright. Information shall not be assigned to a third party without prior consent.

Document control

Status:	Rev:	Comments	Date:	Author:	Reviewer:
Approved			13 June 2013	K O Ballagh	M Morrow

TABLE OF CONTENTS

1.0	INTRODUCTION	4
2.0	CONSTRUCTION.....	4
2.1	Floor build-up constructions.....	4
2.2	Ceiling constructions	5
2.3	Ceiling cavity absorption.....	5
3.0	TEST RESULTS.....	5
4.0	OPINION: BATTEN AND CRADLE™ – BARE FLOOR – NO CAVITY INFILL	6
5.0	OPINION: BATTEN AND CRADLE™ – BARE FLOOR – WITH CAVITY INFILL	7
6.0	OPINION: BATTEN AND CRADLE™ – TILED FLOOR – WITH CAVITY INFILL.....	8
7.0	LIMITATIONS.....	9
8.0	INTERPRETATION	9
8.1	Rating Systems.....	9
8.1.1	NZ Building Code	9
8.1.2	Proposed Building Code (2013).....	9
8.2	Field Performance	9

1.0 INTRODUCTION

Marshall Day Acoustics was asked to provide an opinion on the Impact Insulation Class (IIC) rating that would be achieved by Scyon® Secura™ Interior Flooring used with the Batten and Cradle™ flooring system with a variety of typical concrete floor constructions and Villaboard® ceiling types, with and without cavity insulation. This opinion is based on previous tests of the floor systems on a monolithic test slab and previous tests and computer prediction models of floor and ceiling combinations without the flooring overlay.

2.0 CONSTRUCTION

2.1 Floor build-up constructions

The floor coverings for which the opinion is provided are:

A) *Batten and Cradle™ – Bare Floor – No Cavity Infill*

- 19mm Scyon® Secura™ Interior Flooring flooring system, screw fixed at 200 mm centres to
- Dressed 40 mm x 42 mm finger jointed timber battens spaced at 450 mm centres on
- RC-20 rubber cradles spaced at 450 mm centres
- 65 mm floor cavity with no infill

B) *Batten and Cradle™ – Bare Floor – With Cavity Infill*

- 19mm Scyon® Secura™ Interior Flooring flooring system, screw fixed at 200 mm centres to
- Dressed 40 mm x 42 mm finger jointed timber battens spaced at 450 mm centres on
- RC-20 rubber cradles spaced at 450 mm centres
- 65 mm floor cavity containing 75 mm Pink Batts Silencer

C) *Batten and Cradle™ – Tiled Floor – With Cavity Infill*

- Glazed ceramic PEI 3 tiles 600 mm x 600 mm adhered with monoflex C2S2et Tile Adhesive (applied with a 10 mm notched trowel) to
- 19mm Scyon® Secura™ Interior Flooring flooring system, screw fixed at 200 mm centres to
- Dressed 40 mm x 42 mm finger jointed timber battens spaced at 450 mm centres on
- RC-20 rubber cradles spaced at 450 mm centres
- 65 mm floor cavity containing 75 mm Pink Batts Silencer

2.2 Ceiling constructions

The plasterboard ceilings referred to in Table 1 overleaf are as follows:

- 1 or 2 layers of 9 mm James Hardie Villaboard® (minimum 300 mm ceiling cavity), USG ScrewFix steel frame suspension system comprising 2.5 mm wire hangers at 1200 mm centres supporting DJ38 strongback channels spaced at 600 mm centres maximum. Installed in accordance with manufacturers recommendations.
- The perimeter of the ceiling is sealed with flexible acoustic sealant such as Gib® Soundseal.

2.3 Ceiling cavity absorption

The cavity absorption referred to in Table 1 overleaf is as follows:

- R1.8 Pink Batts, Autex Greenstuff or approved equivalent such as 75 mm thick fibreglass of minimum density 9.6 kg/m³.

3.0 TEST RESULTS

The floor build-up constructions described in Section 2.1 were tested by the University of Auckland Acoustics Testing Service (Test Reports T1006-1, T1006-2 & T1006-3 March 2010). The impact performance of the laboratory test slab was tested with and without the floor covering described.

The impact performance of the constructions was ΔL_w 22 dB, ΔL_w 27 dB, and ΔL_w 31 dB respectively.

4.0 OPINION: BATTEN AND CRADLE™ – BARE FLOOR – NO CAVITY INFILL

The following table details the expected impact performance of floor system A as described in Section 2 with various ceiling and floor slab combinations, including whether ceiling cavity insulation is installed:

Table 1 Batten and Cradle™ – Bare Floor – No Cavity Infill – Impact Insulation Prediction

		Floor					
Ceiling		120 mm Hibond (average concrete thickness 90 mm)	75 mm Unispan + 75 mm topping	200 mm Dycore with 65 mm topping	135 mm Stahkton Rib and Infill (minimum concrete thickness 135 mm on 25 mm timber infills)	90 mm Interspan (minimum concrete thickness 90 mm on 25 mm timber infills)	
Thickness /layers	Cavity Insulation Present?	$L'_{nT,w} (+C_1)$ (See Note 1)	Impact Insulation Class (See Note 1)	$L'_{nT,w} (+C_1)$ (See Note 1)	Impact Insulation Class (See Note 1)	$L'_{nT,w} (+C_1)$ (See Note 1)	
No plasterboard ceiling	N/A	IIC 52	IIC 55	IIC 56	IIC 56	IIC 53	
1 x 10 mm plasterboard	No	IIC 45	IIC 50	IIC 51	IIC 49	IIC 46	
	Yes	IIC 54	IIC 57	IIC 58	IIC 58	IIC 55	
1 x 13 mm plasterboard	No	IIC 49	IIC 55	IIC 55	IIC 53	IIC 50	
	Yes	IIC 65	IIC 68	IIC 69	IIC 69	IIC 66	
2 x 13 mm plasterboard	No	IIC 53	IIC 58	IIC 59	IIC 57	IIC 54	
	Yes	IIC 69	IIC 73	IIC 73	IIC 73	IIC 70	

- Notes: 1. The $L'_{nT,w} (+C_1)$ has been calculated based on a receiving room volume of 50 m³. No allowance has been made for on-site flanking transmission.
 2. Refer to Section 2.0 for construction information in relation to Table 1 above.

Note: This document may be reproduced in full but not in part without the written consent of Marshall Day Acoustics Limited
 J:\PROPOSALS\2013\201305cu\Rp001_201305cu_kob130705_SECURA_opinion.docx

5.0 OPINION: BATTEN AND CRADLE™ – BARE FLOOR – WITH CAVITY INFILL

The following table details the expected impact performance of floor system B as described in Section 2 with various ceiling and floor slab combinations, including whether ceiling cavity insulation is installed:

Table 2: Batten and Cradle™ – Bare Floor – With cavity Infill – Impact Insulation Prediction

		Floor					
Ceiling		120 mm Hibond (average concrete thickness 90 mm)	75 mm Unispan + 75 mm topping	200 mm Dycore with 65 mm topping	120 mm Stahlton Rib and Infill (minimum concrete thickness 135 mm on 25 mm timber infills)	90 mm Interspan (minimum concrete thickness 90 mm on 25 mm timber infills)	
Thickness /layers	Cavity Insulation Present?	$L'_{nT,w} (+C_1)$ (See Note 1)	Impact Insulation Class (See Note 1)	$L'_{nT,w} (+C_1)$ (See Note 1)	Impact Insulation Class (See Note 1)	$L'_{nT,w} (+C_1)$ (See Note 1)	
No plasterboard ceiling	N/A	IIC 57	IIC 64	IIC 65	IIC 62	IIC 58	
1 x 10 mm plasterboard	No	IIC 54	IIC 59	IIC 60	IIC 58	IIC 55	
	Yes	IIC 63	IIC 66	IIC 67	IIC 67	IIC 64	
1 x 13 mm plasterboard	No	IIC 58	IIC 63	IIC 64	IIC 62	IIC 59	
	Yes	IIC 74	IIC 77	IIC 78	IIC 78	IIC 75	
2 x 13 mm plasterboard	No	IIC 62	IIC 67	IIC 68	IIC 65	IIC 63	
	Yes	IIC 78	IIC 81	IIC 82	IIC 82	IIC 79	

- Notes: 1. The $L'_{nT,w} (+C_1)$ has been calculated based on a receiving room volume of 50 m³. No allowance has been made for on-site flanking transmission.
 2. Refer to Section 2.0 for construction information in relation to Table 1 above.

6.0 OPINION: BATTEN AND CRADLE™ – TILED FLOOR – WITH CAVITY INFILL

The following table details the expected impact performance of floor system C as described in Section 2 with various ceiling and floor slab combinations, including whether ceiling cavity insulation is installed:

Table 3 Batten and Cradle™ – Tiled Floor – With cavity Infill – Impact Insulation Prediction

		Floor					
Ceiling		120 mm Hibond (average concrete thickness 90 mm)	75 mm Unispan + 75 mm topping	200 mm Dycore with 65 mm topping	135 mm Stahlton Rib and Infill (minimum concrete thickness 135 mm on 25 mm timber infills)	90 mm Interspan (minimum concrete thickness 90 mm on 25 mm timber infills)	
Thickness /layers	Cavity Insulation Present?	$L'_{nT,w} (+C_1)$ (See Note 1)	Impact Insulation Class (See Note 1)	$L'_{nT,w} (+C_1)$ (See Note 1)	Impact Insulation Class (See Note 1)	$L'_{nT,w} (+C_1)$ (See Note 1)	
No plasterboard ceiling	N/A	IIC 59	IIC 66	IIC 67	IIC 64	IIC 60	
1 x 10 mm plasterboard	No	IIC 57	IIC 62	IIC 63	IIC 61	IIC 58	
	Yes	IIC 66	IIC 69	IIC 70	IIC 70	IIC 67	
1 x 13 mm plasterboard	No	IIC 61	IIC 66	IIC 67	IIC 65	IIC 62	
	Yes	IIC 77	IIC 80	IIC 81	IIC 81	IIC 78	
2 x 13 mm plasterboard	No	IIC 65	IIC 70	IIC 71	IIC 68	IIC 66	
	Yes	IIC 79	IIC 84	IIC 85	IIC 85	IIC 81	

- Notes: 1. The $L'_{nT,w} (+C_1)$ has been calculated based on a receiving room volume of 50 m³. No allowance has been made for on-site flanking transmission.
 2. Refer to Section 2.0 for construction information in relation to Table 1 above..

7.0 LIMITATIONS

The above opinions are an estimate of the laboratory performance not the field performance. The estimate is based on the original laboratory tests, the materials as currently manufactured and the construction details set out above. Readers are advised to check that this opinion has not been revised by a later issue. The estimate is expected to be in error by less than 3 IIC/dB.

8.0 INTERPRETATION

8.1 Rating Systems

8.1.1 NZ Building Code

The Impact Insulation Class (IIC) of a floor/ceiling system reflects its ability to prevent impact on its surface from being transmitted as structure-borne vibration and radiating as air-borne noise. Higher IIC ratings indicate that less noise is transmitted to the room below. The existing NZ Building Code requires that new floors have a laboratory rating of IIC 55 or higher. In addition the floor must be constructed to ensure the on-site Field Impact Insulation Class (IIC) is no less than FIIC 50.

8.1.2 Proposed Building Code (2013)

The current proposed NZ Building Code (G6) requires a Standardised Impact Sound Pressure Level ($L'_{nT,w}$) of 57 dB or less between habitable spaces. This is a rating for the impact sound measured rather than a floor performance rating. Therefore, the lower the $L'_{nT,w}$ the lower the impact noise and correspondingly the higher the performance of the floor.

The calculation of $L'_{nT,w}$ from a laboratory measurement requires an estimation of room size. The results presented in the table above have been based on a receiving room size of 50 m³. It should be noted that the figures would not be appropriate for rooms considerably larger or smaller than 50 m³ and calculation of alternative allowances would be required.

The performance estimates have been made considering only vertical transmission of impact borne sound. It should also be noted that whilst $L'_{nT,w}$ describes a field measurement in this instance, no allowance has been made for on-site flanking transmission and no consideration has been given to horizontal transmission.

8.2 Field Performance

To ensure the on-site measurements are similar to the laboratory results the products must be installed and constructed in a similar way to the laboratory tests and any substitution of materials must be approved by the project's Acoustic Consultant. In addition, potential flanking paths, such as external walls, need to be considered and mitigated against.

Structure-borne vibration is readily transmitted in all directions in concrete flooring substructures. There is often little difference between measured impact noise levels in rooms directly below the source room compared with rooms that are diagonally below. Therefore the impact isolation to rooms other than those directly below the floor area should also be considered.

Where horizontal transmission or flanking is likely to be of concern it is recommended that concrete slabs of no less than 120 mm effective (average) thickness be used. Hard floor surfaces on lightweight concrete floors are likely to require specialist isolation to avoid high levels of impact noise being transmitted to adjacent spaces.

The use of materials other than those referred to in Section 2 or the introduction of additional materials (e.g. underfloor heating), including the lack of any perimeter isolation, can significantly affect the field performance rating (i.e. may result in a failure in accordance with the NZ Building Code). MDA strongly recommend trial performance testing on site before proceeding with full installation.

Note:

This opinion may be reproduced in full but not in part without the written consent of Marshall Day Associates.

**Opinion on Impact Insulation Rating of Scyon® Secura™ Interior Flooring
on Batten & Cradle™ Flooring Systems with a Villaboard® Ceiling**

June 2013



Project: **Opinion on Impact Insulation Rating of Scyon® Secura™
Interior Flooring on Batten & Cradle™ Flooring Systems with
a Villaboard® Ceiling**

Prepared for: **James Hardie Ltd
PO Box 12070
Auckland 1642**

and
**Batten & Cradle™ Acoustic Flooring Ltd
PO Box 5074
New Plymouth 4343**

Report No.: **RP002 201305cu**

Disclaimer

Reports produced by Marshall Day Acoustics Limited are prepared based on the Client's objective and are based on a specific scope, conditions and limitations, as agreed between Marshall Day Acoustics and the Client. Information and/or report(s) prepared by Marshall Day Acoustics may not be suitable for uses other than the original intended objective. No parties other than the Client should use any information and/or report(s) without first conferring with Marshall Day Acoustics.

Copyright

The concepts and information contained in this document are the property of Marshall Day Acoustics Limited. Use or copying of this document in whole or in part without the written permission of Marshall Day Acoustics constitutes an infringement of copyright. Information shall not be assigned to a third party without prior consent.

Document control

Status:	Rev:	Comments	Date:	Author:	Reviewer:
Approved			13 June 2013	K O Ballagh	M Morrow

TABLE OF CONTENTS

1.0	INTRODUCTION	4
2.0	CONSTRUCTION.....	4
2.1	Floor build-up constructions.....	4
2.2	Ceiling constructions	5
2.3	Ceiling cavity absorption.....	5
3.0	TEST RESULTS.....	5
4.0	OPINION: BATTEN AND CRADLE™ – BARE FLOOR – NO CAVITY INFILL.....	6
5.0	OPINION: BATTEN AND CRADLE™ – BARE FLOOR – WITH CAVITY INFILL	7
6.0	OPINION: BATTEN AND CRADLE™ – TILED FLOOR – WITH CAVITY INFILL.....	8
7.0	LIMITATIONS.....	9
8.0	INTERPRETATION	9
8.1	Rating Systems.....	9
8.1.1	NZ Building Code	9
8.1.2	Proposed Building Code (2013).....	9
8.2	Field Performance	9

1.0 INTRODUCTION

Marshall Day Acoustics was asked to provide an opinion on the Impact Insulation Class (IIC) rating that would be achieved by Scyon® Secura™ Interior Flooring used with the Batten and Cradle™ flooring system with a variety of typical concrete floor constructions and Villaboard® ceiling types, with and without cavity insulation. This opinion is based on previous tests of the floor systems on a monolithic test slab and previous tests and computer prediction models of floor and ceiling combinations without the flooring overlay.

2.0 CONSTRUCTION

2.1 Floor build-up constructions

The floor coverings for which the opinion is provided are:

A) *Batten and Cradle™ – Bare Floor – No Cavity Infill*

- 19mm Scyon® Secura™ Interior Flooring flooring system, screw fixed at 200 mm centres to
- Dressed 40 mm x 42 mm finger jointed timber battens spaced at 450 mm centres on
- RC-20 rubber cradles spaced at 450 mm centres
- 65 mm floor cavity with no infill

B) *Batten and Cradle™ – Bare Floor – With Cavity Infill*

- 19mm Scyon® Secura™ Interior Flooring flooring system, screw fixed at 200 mm centres to
- Dressed 40 mm x 42 mm finger jointed timber battens spaced at 450 mm centres on
- RC-20 rubber cradles spaced at 450 mm centres
- 65 mm floor cavity containing 75 mm Pink Batts Silencer

C) *Batten and Cradle™ – Tiled Floor – With Cavity Infill*

- Glazed ceramic PEI 3 tiles 600 mm x 600 mm adhered with monoflex C2S2et Tile Adhesive (applied with a 10 mm notched trowel) to
- 19mm Scyon® Secura™ Interior Flooring flooring system, screw fixed at 200 mm centres to
- Dressed 40 mm x 42 mm finger jointed timber battens spaced at 450 mm centres on
- RC-20 rubber cradles spaced at 450 mm centres
- 65 mm floor cavity containing 75 mm Pink Batts Silencer

2.2 Ceiling constructions

The plasterboard ceilings referred to in Table 1 overleaf are as follows:

- 1 or 2 layers of 9 mm James Hardie Villaboard® (minimum 300 mm ceiling cavity), USG ScrewFix steel frame suspension system comprising 2.5 mm wire hangers at 1200 mm centres supporting DJ38 strongback channels spaced at 600 mm centres maximum. Installed in accordance with manufacturers recommendations.
- The perimeter of the ceiling is sealed with flexible acoustic sealant such as Gib® Soundseal.

2.3 Ceiling cavity absorption

The cavity absorption referred to in Table 1 overleaf is as follows:

- R1.8 Pink Batts, Autex Greenstuff or approved equivalent such as 75 mm thick fibreglass of minimum density 9.6 kg/m³.

3.0 TEST RESULTS

The floor build-up constructions described in Section 2.1 were tested by the University of Auckland Acoustics Testing Service (Test Reports T1006-1, T1006-2 & T1006-3 March 2010). The impact performance of the laboratory test slab was tested with and without the floor covering described.

The impact performance of the constructions was ΔL_w 22 dB, ΔL_w 27 dB, and ΔL_w 31 dB respectively.

4.0 OPINION: BATTEN AND CRADLE™ – BARE FLOOR – NO CAVITY INFILL

The following table details the expected impact performance of floor system A as described in Section 2 with various ceiling and floor slab combinations, including whether ceiling cavity insulation is installed:

Table 1 Batten and Cradle™ – Bare Floor – No Cavity Infill – Impact Insulation Prediction

		Floor					
Ceiling		120 mm Hibond (average concrete thickness 90 mm)	75 mm Unispan + 75 mm topping	200 mm Dycore with 65 mm topping	135 mm Stahlton Rib and Infill (minimum concrete thickness 135 mm on 25 mm timber infills)	90 mm Interspan (minimum concrete thickness 90 mm on 25 mm timber infills)	
Thickness /layers	Cavity Insulation Present?	$L'_{nT,w} (+C_1)$ (See Note 1)	Impact Insulation Class (See Note 1)	$L'_{nT,w} (+C_1)$ (See Note 1)	Impact Insulation Class (See Note 1)	$L'_{nT,w} (+C_1)$ (See Note 1)	
No plasterboard ceiling	N/A	IIC 52	IIC 55	IIC 56	IIC 56	IIC 53	
1 x 9 mm Villaboard®	No	IIC 51	IIC 56	IIC 57	IIC 55	IIC 52	
	Yes	IIC 68	IIC 71	IIC 72	IIC 72	IIC 69	
2 x 9 mm Villaboard®	No	IIC 55	IIC 60	IIC 61	IIC 59	IIC 56	
	Yes	IIC 71	IIC 74	IIC 75	IIC 75	IIC 72	

- Notes: 1. The $L'_{nT,w} (+C_1)$ has been calculated based on a receiving room volume of 50 m³. No allowance has been made for on-site flanking transmission.
 2. Refer to Section 2.0 for construction information in relation to Table 1 above.

5.0 OPINION: BATTEN AND CRADLE – BARE FLOOR – WITH CAVITY INFILL

The following table details the expected impact performance of floor system B as described in Section 2 with various ceiling and floor slab combinations, including whether ceiling cavity insulation is installed:

Table 2: Batten and Cradle – Bare Floor – With cavity Infill – Impact Insulation Prediction

		Floor					
Ceiling		120 mm Hibond (average concrete thickness 90 mm)	75 mm Unispan + 75 mm topping	200 mm Dycore with 65 mm topping	120 mm Stahlton Rib and Infill (minimum concrete thickness 135 mm on 25 mm timber infills)	90 mm Interspan (minimum concrete thickness 90 mm on 25 mm timber infills)	
Thickness /layers	Cavity Insulation Present?	$L'_{nT,w} (+C_1)$ (See Note 1)	Impact Insulation Class (See Note 1)	$L'_{nT,w} (+C_1)$ (See Note 1)	Impact Insulation Class (See Note 1)	$L'_{nT,w} (+C_1)$ (See Note 1)	
No plasterboard ceiling	N/A	IIC 57	IIC 64	IIC 65	IIC 62	IIC 58	
1 x 9 mm Villaboard®	No	IIC 60	IIC 65	IIC 66	IIC 64	IIC 61	
	Yes	IIC 76	IIC 80	IIC 80	IIC 80	IIC 77	
2 x 9 mm Villaboard®	No	IIC 64	IIC 69	IIC 70	IIC 68	IIC 65	
	Yes	IIC 79	IIC 83	IIC 84	IIC 83	IIC 80	

- Notes: 1. The $L'_{nT,w} (+C_1)$ has been calculated based on a receiving room volume of 50 m³. No allowance has been made for on-site flanking transmission.
 2. Refer to Section 2.0 for construction information in relation to Table 1 above.

6.0 OPINION: BATTEN AND CRADLE™ – TILED FLOOR – WITH CAVITY INFILL

The following table details the expected impact performance of floor system C as described in Section 2 with various ceiling and floor slab combinations, including whether ceiling cavity insulation is installed:

Table 3 Batten and Cradle™ – Tiled Floor – With cavity Infill – Impact Insulation Prediction

		Floor					
Ceiling		120 mm Hibond (average concrete thickness 90 mm)	75 mm Unispan + 75 mm topping	200 mm Dycore with 65 mm topping	135 mm Stahlton Rib and Infill (minimum concrete thickness 135 mm on 25 mm timber infills)	90 mm Interspan (minimum concrete thickness 90 mm on 25 mm timber infills)	
Thickness /layers	Cavity Insulation Present?	$L'_{nT,w} (+C_1)$ (See Note 1)	Impact Insulation Class (See Note 1)	$L'_{nT,w} (+C_1)$ (See Note 1)	Impact Insulation Class (See Note 1)	$L'_{nT,w} (+C_1)$ (See Note 1)	
No plasterboard ceiling	N/A	IIC 59	IIC 66	IIC 67	IIC 64	IIC 60	
1 x 9 mm Villaboard®	No	IIC 63	IIC 68	IIC 69	IIC 67	IIC 64	
	Yes	IIC 79	IIC 83	IIC 83	IIC 83	IIC 80	
2 x 9 mm Villaboard®	No	IIC 67	IIC 72	IIC 73	IIC 71	IIC 68	
	Yes	IIC 80	IIC 86	IIC 87	IIC 86	IIC 82	

Notes: 1. The $L'_{nT,w} (+C_1)$ has been calculated based on a receiving room volume of 50 m³. No allowance has been made for on-site flanking transmission.

7.0 LIMITATIONS

The above opinions are an estimate of the laboratory performance not the field performance. The estimate is based on the original laboratory tests, the materials as currently manufactured and the construction details set out above. Readers are advised to check that this opinion has not been revised by a later issue. The estimate is expected to be in error by less than 3 IIC/dB.

8.0 INTERPRETATION

8.1 Rating Systems

8.1.1 NZ Building Code

The Impact Insulation Class (IIC) of a floor/ceiling system reflects its ability to prevent impact on its surface from being transmitted as structure-borne vibration and radiating as air-borne noise. Higher IIC ratings indicate that less noise is transmitted to the room below. The existing NZ Building Code requires that new floors have a laboratory rating of IIC 55 or higher. In addition the floor must be constructed to ensure the on-site Field Impact Insulation Class (IIC) is no less than FIIC 50.

8.1.2 Proposed Building Code (2013)

The current proposed NZ Building Code (G6) requires a Standardised Impact Sound Pressure Level ($L'_{nT,w}$) of 57 dB or less between habitable spaces. This is a rating for the impact sound measured rather than a floor performance rating. Therefore, the lower the $L'_{nT,w}$ the lower the impact noise and correspondingly the higher the performance of the floor.

The calculation of $L'_{nT,w}$ from a laboratory measurement requires an estimation of room size. The results presented in the table above have been based on a receiving room size of 50 m³. It should be noted that the figures would not be appropriate for rooms considerably larger or smaller than 50 m³ and calculation of alternative allowances would be required.

The performance estimates have been made considering only vertical transmission of impact borne sound. It should also be noted that whilst $L'_{nT,w}$ describes a field measurement in this instance, no allowance has been made for on-site flanking transmission and no consideration has been given to horizontal transmission.

8.2 Field Performance

To ensure the on-site measurements are similar to the laboratory results the products must be installed and constructed in a similar way to the laboratory tests and any substitution of materials must be approved by the project's Acoustic Consultant. In addition, potential flanking paths, such as external walls, need to be considered and mitigated against.

Structure-borne vibration is readily transmitted in all directions in concrete flooring substructures. There is often little difference between measured impact noise levels in

rooms directly below the source room compared with rooms that are diagonally below. Therefore the impact isolation to rooms other than those directly below the floor area should also be considered.

Where horizontal transmission or flanking is likely to be of concern it is recommended that concrete slabs of no less than 120 mm effective (average) thickness be used. Hard floor surfaces on lightweight concrete floors are likely to require specialist isolation to avoid high levels of impact noise being transmitted to adjacent spaces.

The use of materials other than those referred to in Section 2 or the introduction of additional materials (e.g. underfloor heating), including the lack of any perimeter isolation, can significantly affect the field performance rating (i.e. may result in a failure in accordance with the NZ Building Code). MDA strongly recommend trial performance testing on site before proceeding with full installation.

Note:

This opinion may be reproduced in full but not in part without the written consent of Marshall Day Associates.



**Opinion on Impact Insulation Rating of Batten & Cradle™
Flooring Systems**

June 2010



Project: **Opinion on Impact Insulation Rating of Batten & Cradle™ Flooring Systems**

Prepared for: **Batten & Cradle™ Acoustic Flooring Ltd
PO Box 5074
New Plymouth 4343**

Report No.: **Rp001 r01 201005bt**

Document control

Status:	Issue:	Date:	Prepared by:	Reviewed by:
Current	R01	3 June 2010	M S Dunn	J Valentine

Note: This document may be reproduced in full but not in part without the written consent of Marshall Day Acoustics Limited

TABLE OF CONTENTS

1.0	INTRODUCTION	4
2.0	CONSTRUCTION.....	4
2.1	Floor covering constructions	4
2.2	Cavity absorption.....	5
2.3	Ceiling construction.....	5
3.0	TEST RESULTS	5
4.0	OPINION: BATTEN AND CRADLE™ – BARE FLOOR – NO CAVITY INFILL	6
5.0	OPINION: BATTEN AND CRADLE™ – BARE FLOOR – WITH CAVITY INFILL	7
6.0	OPINION: BATTEN AND CRADLE™ – TILED FLOOR – WITH CAVITY INFILL.....	8
7.0	LIMITATIONS.....	9
8.0	INTERPRETATION	9
8.1	Rating Systems.....	9
8.1.1	NZ Building Code	9
8.1.2	Proposed Building Code.....	9
8.2	Field Performance	10

1.0 INTRODUCTION

Marshall Day Acoustics was asked to provide an opinion on the Impact Insulation Class (IIC) rating that would be achieved by variations of the Batten and Cradle™ flooring system with variety of typical concrete floor constructions and ceiling types, with and without cavity insulation. This opinion is based on previous tests of the floor systems on a monolithic test slab and previous tests and computer prediction models of floor and ceiling combinations without the flooring overlay.

2.0 CONSTRUCTION

2.1 Floor build-up constructions

The floor coverings for which the opinion is provided are:

A - Batten and Cradle™ – Bare Floor – No Cavity Infill

- 20 mm Strandfloor tongue and groove flooring system, screw fixed at 200 mm centres to
- Dressed 42 mm x 42 mm fingerjoint timber battens spaced at 450 mm centres on
- RC-20 rubber cradles spaced at 450 mm centres
- 65 mm floor cavity with no infill

B - Batten and Cradle™ – Bare Floor – With Cavity Infill

- 20 mm Strandfloor tongue and groove flooring system, screw fixed at 200 mm centres to
- Dressed 42 mm x 42 mm finger joint timber battens spaced at 450 mm centres on
- RC-20 rubber cradles spaced at 450 mm centres
- 65 mm floor cavity containing 75 mm Pink Batts Silencer

C - Batten and Cradle™ – Tiled Floor – With Cavity Infill

- Glazed ceramic PEI 3 tiles 600 mm x 600 mm adhered with monoflex C2S2et Tile Adhesive (applied with a 10 mm notched trowel) to
- 6 mm James Hardie Tile Underlay, screw fixed to
- 20 mm Standfloor tongue and groove flooring system, screw fixed at 200 mm centres to

- Dressed 42 mm x 42 mm finger joint timber battens spaced at 450 mm centres on
- RC-20 rubber cradles spaced at 450 mm centres
- 65 mm floor cavity containing 75 mm Pink Batts Silencer

2.2 Ceiling constructions

The plasterboard ceilings referred to in Table 1 overleaf are as follows:

- 10 mm standard Gib® on Gib Rondo or USG ScrewFix ceiling batten system, minimum 100 mm ceiling cavity,
- 13 mm standard Gib® or 2 layers of 13 mm standard Gib® as specified (minimum 300 mm ceiling cavity), USG ScrewFix steel frame suspension system comprising 2.5 mm wire hangers at 1200 mm centres supporting DJ38 strongback channels spaced at 600 mm centres maximum. installed in accordance with manufacturers recommendations.
- The perimeter of the ceiling is sealed with flexible acoustic sealant such as Gib® Soundseal.

2.3 Ceiling cavity absorption

The cavity absorption referred to in Table 1 overleaf is as follows:

- R1.8 Pink Batts, Autex Greenstuff or approved equivalent such as 75 mm thick fibreglass of minimum density 9.6 kg/m³.

3.0 TEST RESULTS

The floor build-up constructions described in Section 2.1 were tested by the University of Auckland Acoustics Testing Service (Test Reports T1006-1, T1006-2 & T1006-3 March 2010). The impact performance of the laboratory test slab was tested with and without the floor covering described.

The impact performance of the constructions was ΔL_w 22 dB, ΔL_w 27 dB, ΔL_w 31 dB respectively.

4.0 OPINION: BATTEN AND CRADLE™ – BARE FLOOR – NO CAVITY INFILL

The following table details the expected impact performance of floor system A as described in Section 2.0 with various ceiling and floor slab combinations, including whether cavity insulation is installed:

Table 1 Batten and Cradle™ – Bare Floor – No Cavity Infill – Impact Insulation Prediction

		Floor					
	Ceiling	120 mm Hibond (average concrete thickness 90 mm)	75 mm Unispan + 75 mm topping	200 mm Dycore with 65 mm topping	135 mm Stahlton Rib and Infill (minimum concrete thickness 135 mm on 25 mm timber infills)	90 mm Interspan (minimum concrete thickness 90 mm on 25 mm timber infills)	
Thickness /layers	Cavity Insulation Present?	$L'_{nt,w} (+C_1)$ (See Note 1)	Impact Insulation Class (See Note 1)	$L'_{nt,w} (+C_1)$ (See Note 1)	Impact Insulation Class (See Note 1)	$L'_{nt,w} (+C_1)$ (See Note 1)	
No plasterboard ceiling	N/A	IIC 48	IIC 53	IIC 54	IIC 53	IIC 48	
1 x 10 mm plasterboard	No	IIC 42	IIC 50	IIC 51	IIC 49	IIC 42	
	Yes	IIC 50	IIC 55	IIC 56	IIC 55	IIC 50	
1 x 13 mm plasterboard	No	IIC 46	IIC 54	IIC 55	IIC 53	IIC 46	
	Yes	IIC 61	IIC 68	IIC 69	IIC 67	IIC 61	
2 x 13 mm plasterboard	No	IIC 50	IIC 58	IIC 58	IIC 56	IIC 50	
	Yes	IIC 65	IIC 73	IIC 74	IIC 71	IIC 65	

- Notes:
- The $L'_{nt,w} (+C_1)$ has been calculated based on a receiving room volume of 50 m³. No allowance has been made for on-site flanking transmission.
 - Refer to Section 2.0 for construction information in relation to Table 1 above.

Note: This document may be reproduced in full but not in part without the written consent of Marshall Day Acoustics Limited
 J:\PROPOSALS\2010\201005bt\Rp001_r01_201005bt batten and cradle opinion.doc

5.0 OPINION: BATTEN AND CRADLE – BARE FLOOR – WITH CAVITY INFILL

The following table details the expected impact performance of floor system B as described in Section 2.0 with various ceiling and floor slab combinations, including whether cavity insulation is installed:

Table 2: Batten and Cradle – Bare Floor – With cavity Infill – Impact Insulation Prediction

		Floor									
Ceiling		120 mm Hibond (average concrete thickness 90 mm)	75 mm Unispan + 75 mm topping	200 mm Dycore with 65 mm topping	135 mm Stahlton Rib and Infill (minimum concrete thickness 135 mm on 25 mm timber infills)	90 mm Interspan (minimum concrete thickness 90 mm on 25 mm timber infills)					
Thickness /layers	Cavity Insulation Present?	$L'_{nt,w} (+C_1)$ (See Note 1)	Impact Insulation Class (See Note 1)	$L'_{nt,w} (+C_1)$ (See Note 1)	Impact Insulation Class (See Note 1)	$L'_{nt,w} (+C_1)$ (See Note 1)	Impact Insulation Class (See Note 1)	$L'_{nt,w} (+C_1)$ (See Note 1)	Impact Insulation Class (See Note 1)	$L'_{nt,w} (+C_1)$ (See Note 1)	Impact Insulation Class (See Note 1)
No plasterboard ceiling	N/A	57 (+2) dB	IIC 55	51 (+2) dB	IIC 56	50 (+1) dB	IIC 54	52 (+2) dB	IIC 49	57 (+2) dB	IIC 49
1 x 10 mm plasterboard	No	58 (+5) dB	IIC 50	50 (+5) dB	IIC 51	49 (+5) dB	IIC 49	50 (+6) dB	IIC 42	58 (+5) dB	IIC 42
1 x 13 mm plasterboard	Yes	48 (+7) dB	IIC 56	43 (+6) dB	IIC 56	41 (+8) dB	IIC 55	44 (+6) dB	IIC 50	48 (+7) dB	IIC 50
1 x 13 mm plasterboard	No	53 (+6) dB	IIC 54	45 (+6) dB	IIC 55	44 (+7) dB	IIC 53	46 (+6) dB	IIC 46	53 (+6) dB	IIC 46
1 x 13 mm plasterboard	Yes	38 (+6) dB	IIC 68	31 (+6) dB	IIC 69	30 (+6) dB	IIC 67	33 (+5) dB	IIC 62	38 (+6) dB	IIC 62
2 x 13 mm plasterboard	No	49 (+6) dB	IIC 58	40 (+7) dB	IIC 59	40 (+7) dB	IIC 57	42 (+7) dB	IIC 50	49 (+6) dB	IIC 50
2 x 13 mm plasterboard	Yes	35 (+5) dB	IIC 73	28 (+5) dB	IIC 74	27 (+5) dB	IIC 72	29 (+5) dB	IIC 65	35 (+5) dB	IIC 65

- Notes:
- The $L'_{nt,w} (+C_1)$ has been calculated based on a receiving room volume of 50 m³. No allowance has been made for on-site flanking transmission.
 - Refer to Section 2.0 for construction information in relation to Table 1 above.

Note: This document may be reproduced in full but not in part without the written consent of Marshall Day Acoustics Limited
 J:\PROPOSALS\2010\201005bt\Rp001_r01_201005bt batten and cradle opinion.doc

6.0 OPINION: BATTEN AND CRADLE™ – TILED FLOOR – WITH CAVITY INFILL

The following table details the expected impact performance of floor system C as described in Section 2.0 with various ceiling and floor slab combinations, including whether cavity insulation is installed:

Table 3 Batten and Cradle™ – Tiled Floor – With cavity Infill – Impact Insulation Prediction

		Floor					
Ceiling		120 mm Hibond (average concrete thickness 90 mm)	75 mm Unispan + 75 mm topping	200 mm Dycore with 65 mm topping	135 mm Stahlton Rib and Infill (minimum concrete thickness 135 mm on 25 mm timber infills)	90 mm Interspan (minimum concrete thickness 90 mm on 25 mm timber infills)	
Thickness /layers	Cavity Insulation Present?	$L'_{nt,w} (+C_1)$ (See Note 1)	Impact Insulation Class (See Note 1)	$L'_{nt,w} (+C_1)$ (See Note 1)	Impact Insulation Class (See Note 1)	$L'_{nt,w} (+C_1)$ (See Note 1)	Impact Insulation Class (See Note 1)
No plasterboard ceiling	N/A	IIC 55	IIC 61	IIC 62	IIC 60	IIC 55	IIC 55
1 x 10 mm plasterboard	No	IIC 49	IIC 57	IIC 58	IIC 56	IIC 49	IIC 49
	Yes	IIC 56	IIC 62	IIC 63	IIC 61	IIC 56	IIC 56
1 x 13 mm plasterboard	No	IIC 53	IIC 61	IIC 61	IIC 60	IIC 53	IIC 53
	Yes	IIC 68	IIC 75	IIC 76	IIC 74	IIC 68	IIC 68
2 x 13 mm plasterboard	No	IIC 56	IIC 64	IIC 65	IIC 63	IIC 56	IIC 56
	Yes	IIC 72	IIC 80	IIC 80	IIC 78	IIC 72	IIC 72

- Notes:
1. The $L'_{nt,w} (+C_1)$ has been calculated based on a receiving room volume of 50 m³. No allowance has been made for on-site flanking transmission.
 2. Refer to Section 2.0 for construction information in relation to Table 1 above.

7.0 LIMITATIONS

The above opinions are an estimate of the laboratory performance not the field performance. The estimate is based on the original laboratory tests, the materials as currently manufactured and the construction details set out above. Readers are advised to check that this opinion has not been revised by a later issue. The estimate is expected to be in error by less than 3 IIC/dB.

8.0 INTERPRETATION

8.1 Rating Systems

8.1.1 NZ Building Code

The Impact Insulation Class (IIC) of a floor/ceiling system reflects its ability to prevent impact on its surface from being transmitted as structure-borne vibration and radiating as air-borne noise. Higher IIC ratings indicate that less noise is transmitted to the room below. The existing NZ Building Code requires that new floors have a laboratory rating of IIC 55 or higher. In addition the floor must be constructed to ensure the on-site Field Impact Insulation Class (IIC) is no less than FIIC 50.

8.1.2 Proposed Building Code

The proposed NZ Building Code (G6) requires a Standardised Impact Sound Pressure Level + Impact Spectrum Adaptation Term ($L'_{nT,w} + C_1$) of 55 dB or less between habitable spaces. This is a rating for the impact sound measured rather than a floor performance rating. Therefore, the lower the $L'_{nT,w} + C_1$ the lower the impact noise and correspondingly the higher the performance of the floor. The Impact Spectrum Adaptation Term C_1 has been included as, according to the proposed Building Code, this has “been shown to better relate to the problem of low frequency footfall noise, and also high frequency impact sound, such as chairs scraping on hard surfaces.” For concrete floors the C_1 figure tends to be negative.

The calculation of $L'_{nT,w} + C_1$ from a laboratory measurement requires an estimation of room size. The results presented in the table above have been based on a receiving room size of 50 m³. It should be noted that the figures would not be appropriate for rooms considerably larger or smaller than 50 m³ and calculation of alternative allowances would be required.

The performance estimates have been made considering only vertical transmission of impact borne sound. It should also be noted that whilst $L'_{nT,w} + C_1$ describes a field measurement in this instance, no allowance has been made for on-site flanking transmission and no consideration has been given to horizontal transmission.

8.2 Field Performance

To ensure the on-site measurements are similar to the laboratory results the products must be installed and constructed in a similar way to the laboratory tests and any substitution of materials must be approved by the project's Acoustic Consultant. In addition, potential flanking paths, such as external walls, need to be considered and mitigated against.

Structure-borne vibration is readily transmitted in all directions in concrete flooring substructures. There is often little difference between measured impact noise levels in rooms directly below the source room compared with rooms that are diagonally below. Therefore the impact isolation to rooms other than those directly below the floor area should also be considered.

Where horizontal transmission or flanking is likely to be of concern it is recommended that concrete slabs of no less than 120 mm effective (average) thickness be used. Hard floor surfaces on lightweight concrete floors are likely to require specialist isolation to avoid high levels of impact noise being transmitted to adjacent spaces.

The use of materials other than those referred to in Section 2 or the introduction of additional materials (e.g. underfloor heating), including the lack of any perimeter isolation, can significantly affect the field performance rating (i.e. may result in a failure in accordance with the NZ Building Code). MDA strongly recommend trial performance testing on site before proceeding with full installation.

Note:

This opinion may be reproduced in full but not in part without the written consent of Marshall Day Associates.



James Hardie Secura Interior Flooring and Batten and Cradle Flooring Systems provide a high performance solution for medium density housing development in Hobsonville Point



Featured products

Secura™ Interior Flooring

Batten and Cradle Flooring System™

Project details

Location: Hobsonville Point, West Auckland

Project Size: 5,584 sqm

Project Type: Medium Density Housing

Architectural Designer: Stevens Lawson Architects

Project Management: Jalcon Homes

October 2016

A unique solution to Auckland's housing woes

Extending out into the stunning Waitemata Harbour, Hobsonville Point is the location of New Zealand's largest residential building project and Auckland's most livable community. The project is being facilitated by the Hobsonville Land Company, a subsidiary of Housing New Zealand, in answer to Auckland's housing crisis.

Skyrocketing house prices and an increasing population means more people are turning to medium-density housing in Auckland. Hobsonville Point is one of many new subdivisions increasing the supply of this affordable living solution.

The development site is approximately 167 hectares in area and will comprise more than 3,000 homes of different types, divided into precincts. The Sierra Terraces precinct, designed by award-winning architects Stevens Lawson and built by Jalcon Homes, is situated in the heart of this new community and includes a range of affordable housing options that make creative use of smaller land sizes.

Sierra Terraces has been designed to maximise light and space, to create high quality, affordable living environments with materials that are built to last. In this medium density development, the intertenancy walls and floors of the homes needed to meet stringent New Zealand Building Code (NZBC) acoustic performance and fire rating requirements.

The choice of materials for this project, including innovative flooring, reflects the vision for Hobsonville Point to build a strong, thriving community by creating homes that are well designed, well built, and energy efficient, while meeting the fire and acoustic requirements of NZBC.

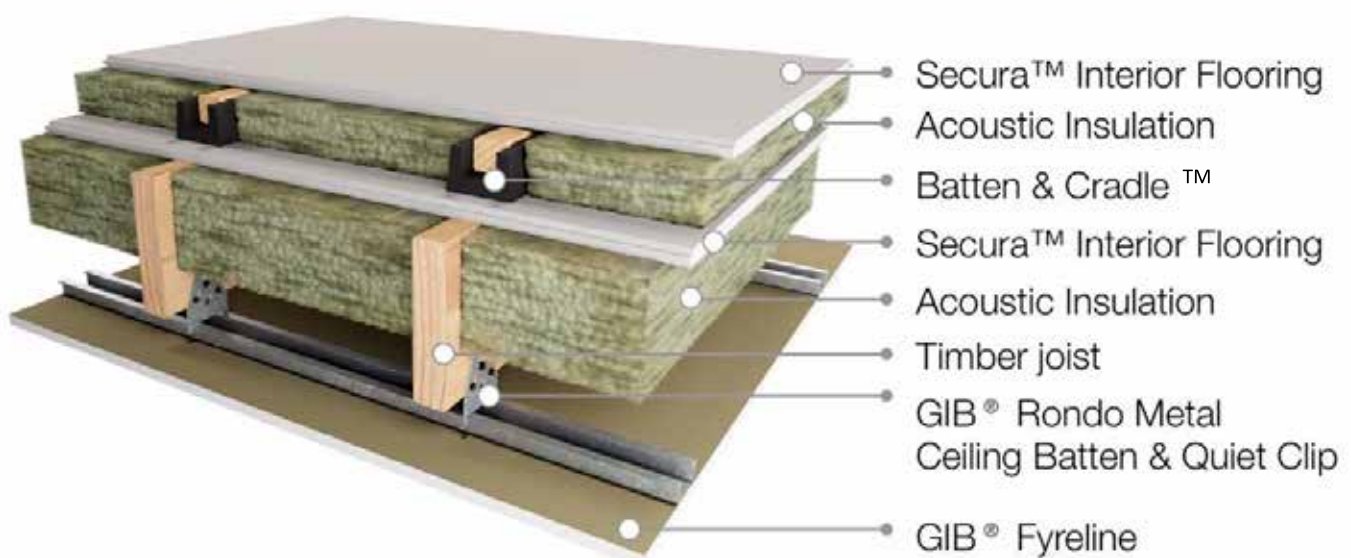

James Hardie Secura Interior Flooring was specified because it ticked all these boxes. The Fire and Acoustic Floor System utilises a timber joist construction method with Secura flooring fixed to timber battens over rubber cradle system. This forms a structural floor system that provides excellent acoustic and fire resistance performance, required for intertenancy floors to comply with NZBC.

The flooring system underwent field testing by Marshall Day Acoustics in August 2016; achieving scores of 60 FSTC and 55 FIIC, both scores are well above the minimum requirements of NZBC.

Cameron Baker, Design Manager for Jalcon Homes, says that this flooring system allowed them to achieve the highest fire safety and acoustic rating possible, while avoiding using concrete in the structure. “With constraints such as extremely tight sites and narrow roads, we could lift most of the product up by hand if we needed to do so. It was a solution we could work with on site.”



During construction James Hardie representatives were on hand to provide support. “They helped us a lot, especially in the early stages providing us with testing and details, and helping us to find the right flooring solution,” says Baker, “They have been excellent.”

James Hardie’s Technical Support Manager, Singh Kamboj, says Secura flooring performs well in medium density typologies because it is specifically engineered to minimize impact and airborne sound, to achieve noise reduction and fire safety. “Homeowners require modern technology and innovation in new builds; they want a house without compromise and don’t want to hear their neighbours above them or be concerned by fire safety. Secura flooring fit the brief perfectly on the Sierra Terraces project.”

Secura flooring is an all in one product - it can be tiled directly without the need for underlay, saving time and money on the build, which also contributes to the affordability of these homes.

Its rigidity gives a squeak-free, solid feel under carpet, tiles or vinyl, and the system helps absorb sound. The rubber cradles absorb impact noise, and the Secura flooring formulation absorbs airborne noise; providing optimum acoustic performance.

The acoustic properties coupled with the fire resistance rating mean James Hardie's Secura-batten and cradle system are ideal for medium density builds. Although Sierra Terrace is the first residential development to use this system, it's also being used on other Jalcon Homes' developments in the area, including a 16-unit development on another Hobsonville site.



Project Manager for Jalcon Homes says, *“There are no other products like this, as far as timber-framed construction goes. This development is unique; intertenancy mid-floors haven't been done in Hobsonville before. It's all geared towards the acoustic performance of the building, which should be much higher than simply meeting the NZBC requirements.”*

Through the use of innovative, high quality materials Jalcon Homes has created a unique urban development within Hobsonville Point that is accessible to a diverse range of New Zealanders who are seeking a close-knit, coastal community to live, work, and play.

Ask James Hardie™ | 0800 808 868 | info@jameshardie.co.nz

12 August 2016

James Hardie
PO Box 12070
Penrose
Auckland 1642

Attention: Singh Kamboj

Dear Singh

HOBSONVILLE POINT IIC AND STC TEST

Marshall Day Acoustics was engaged to carry out airborne and impact sound insulation tests on the inter-tenancy floor/ceiling system at the new dwellings on the corner of Hobsonville Point Road and De Havilland Road. The tests were undertaken on 2 August, 2016 and were carried out to assess the performance of the system against the New Zealand Building Code Clause G6.

NZ BUILDING CODE REQUIREMENTS

Airborne Sound

With respect to airborne sound transmission, the NZ Building Code specifies that walls and floor/ceiling assemblies must achieve a Sound Transmission Class rating of at least STC 55 in laboratory. This applied to walls/floors between habitable spaces of separate tenancies, and to walls/floors between a common space and a habitable space. Habitable spaces are areas such as living rooms, bedrooms and offices, but not bathrooms, laundries or corridors.

A 5 point leeway is permitted on site, so that the minimum requirement on site is FSTC 50 (Field Sound Transmission Class).

Impact sound

With respect to transmission of impact sound (e.g. footfall noise), Clause G6 of the NZ Building Code specifies that floor/ceiling assemblies must achieve an Impact Insulation Class rating of at least IIC 55 in laboratory. Again, this only applied into rooms such as living rooms and bedrooms that are defined as habitable spaces.

A 5 point leeway is permitted on site, so that the minimum requirement on site is FIIC 50 (Field Impact Insulation Class).

DESCRIPTION OF TEST CONSTRUCTION

The flooring system tested is described below and is illustrated in Figure 1.

- 19mm Secura Interior flooring on
- Batten and Cradle™ floor system with timber battens at 450mm centres sitting on Acoustiflor cradles at 450mm centres with insulation in the cavity on
- 19mm Secura Interior flooring on
- 200mm timber joists with GIB Quiet Clips and one layer of 16mm GIB Fyrelite

Figure 1: Floor construction

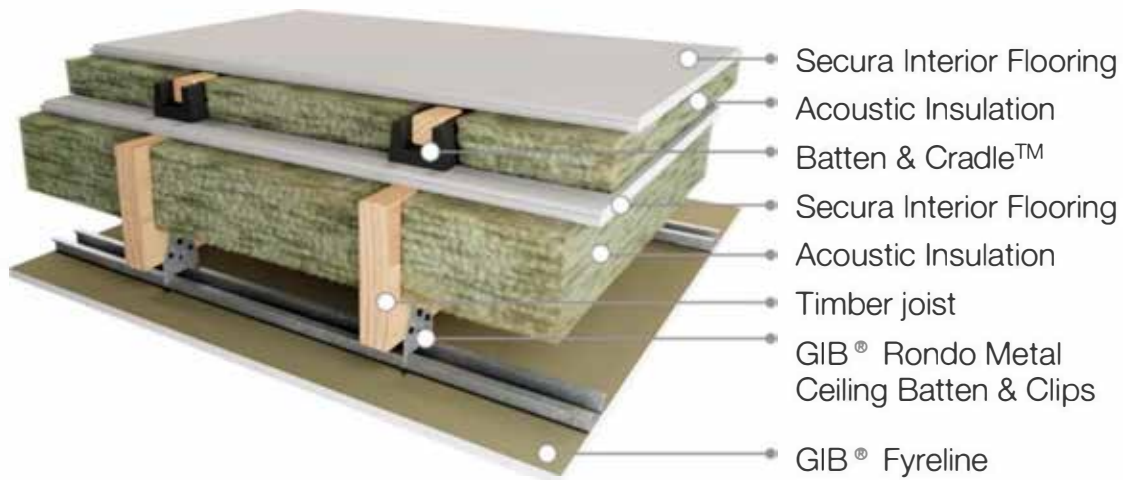

TESTING PROCEDURES & METHODOLOGY

A calibration check was made both prior to and after the tests and no significant drift was observed.

Airborne sound insulation

The performance for airborne sound insulation has been carried out and verified using the procedures detailed in ASTM E 336, and the field sound transmission class verified using the method described in ASTM E 413.

The loudspeaker was placed in the source room in a position to generate an even distribution of sound throughout the room. The sound analyser was used to generate a steady random noise signal (pink noise) which was reproduced via the loudspeaker source. The sound pressure level was measured in the source room and receiving room over the one-third octave band frequency range 100 Hz to 4000 Hz. Two measurements were made using a moving microphone sweep in each room with a measurement period of ten seconds.

The source was then moved to a new position in the source room and the foregoing tests were repeated.

Following this, a measurement was made to determine the reverberation time in each of the one-third octave bands between 100 Hz and 4000 Hz within the receiving room. An internal programme of the sound level meter was used to generate and cut off the random noise signal, which was reproduced in the room by the active loudspeaker source, and to measure the decay rate of the sound in the room.

The background noise level was measured in the receiving room for a period of 10 seconds.

Impact sound insulation

The performance for impact sound insulation has been carried out and verified using the procedures detailed in ISO 140: Part VII, and the field impact insulation class verified using the method described in ASTM E 989.

The tapping machine was placed on the floor in the source room. The machine was set into operation to generate cyclic impacts on top of the floor. The sound pressure level was measured in the receiving room over the one-third octave band frequency range 100 Hz to 4000 Hz by averaging over two moving microphone sweeping measurement positions for each of four tapping machine locations, to give a total of eight measurements, with each measurement period being ten seconds. Each tapping machine position was placed so that it would not have been parallel to the flooring beams. The measurement positions were selected to determine the average sound level over the whole of the room.

Following this, a measurement was made to determine the reverberation time in each of the one-third octave bands between 100 Hz and 4000 Hz within the receiving room. An internal programme of the sound

level meter was used to generate and cut off the random noise signal, which was reproduced in the room by the active loudspeaker source, and to measure the decay rate of the sound in the room.

The background noise level was measured in the receiving room for a period of 10 seconds.

AIRBORNE SOUND INSULATION TESTS

Table 1 summarises the impact sound insulation tests performed and reports the measured performance with comparison against the Building Code criteria.

Table 1: Airborne Performance Test

Source Room	Receiver Room	Common Floor Area	Receiver Room Volume	Measured Performance (FSTC)	Minimum Requirement (FSTC)	Result
Upstairs Living Room	Downstairs Living Room	≈22 m ²	≈60 m ³	62	50	Pass

IMPACT SOUND INSULATION TESTS

Table 2 summarises the impact sound insulation tests performed and reports the measured performance with comparison against the Building Code criteria.

Table 2: Impact Performance Test

Source Room	Receiver Room	Common Floor Area	Receiver Room Volume	Measured Performance (FIIC)	Minimum Requirement (FIIC)	Result
Upstairs Living Room	Downstairs Living Room	≈22 m ²	≈60 m ³	55	50	Pass

Detailed testing results are appended to this letter.

Yours faithfully

MARSHALL DAY ACOUSTICS LTD

Micky Yang

Acoustician

**Apparent sound reduction index according to ISO 140-4
Field measurements of airborne sound insulation between rooms**

Client: James Hardie

Date of test: 2/08/2016

Description and identification of the building construction and test arrangement, direction of measurement:

In-situ test of the flooring system.

19mm Secura Interior flooring on;
Batten and Cradle™ floor system with timber battens at 450mm centres sitting on
Acoustiflor cradles at 450mm centres with insulation in the cavity on;
19mm Secura Interior flooring on;
200mm timber joists on GIB Rondo Quiet Clips and one layer of 16mm Fyreline

*The description of the construction was provided by the client and was not able to be verified by Marshall Day Acoustics
For further details of tests please refer to accompanying letter*

Area S of separating element: 22 m²
Receiving room volume: 60 m³
Source room volume: N/A

— frequency range according to the
— curve of reference values (ISO 717-1)

Frequency f Hz	R' (one-third octave) dB
50	33
63	35
80	36
100	41
125	46
160	47
200	50
250	48
315	53
400	58
500	61
630	65
800	66
1k	67
1k25	64
1k6	62
2k	68
2k5	71
3k15	70
4k	71
5k	68

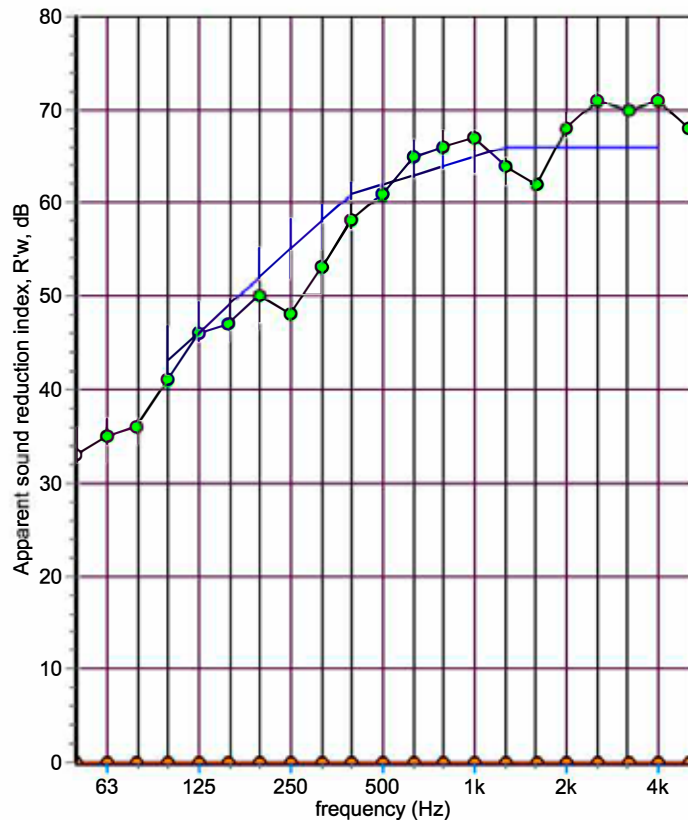

Rating according to ISO 717-1

R',w(C;Ctr) = 62 (-2; -6) dB; C50-3150 = -3 dB; C50-5000 = -2 dB; C100-5000 = -1 dB;

Evaluation based on field measurement results obtained by an engineering method Ctr50-3150 = -11 dB; Ctr50-5000 = -11 dB; Ctr100-5000 = -6 dB;

Rating according to ASTM E413-87

Field Sound Transmission Class = 62

No. of test report : 2015159A

Name of test institute : Marshall Day Acoustics

Date : 18 Aug 16

Signature :

**Normalized impact sound pressure levels according to ISO 140-7
Field measurements of impact sound insulation of floors**

Client: James Hardie

Date of test: 2/08/2016

Description and identification of the building construction and test arrangement, direction of measurement:

In-situ test of the flooring system.

19mm Secura Interior flooring on;
Batten and Cradle™ floor system with timber battens at 450mm centres sitting on
Acoustiflor cradles at 450mm centres with insulation in the cavity on;
19mm Secura Interior flooring on;
200mm timber joists on GIB Rondo Quiet Clips and one layer of 16mm Fyreline

*The description of the construction was provided by the client and was not able to be verified by Marshall Day Acoustics
For further details of tests please refer to accompanying letter*

Receiving room volume: N/A

— frequency range according to the
— curve of reference values (ISO 717-2)

Frequency f Hz	L'n (one-third octave) dB
50	61
63	62
80	64
100	65
125	63
160	61
200	61
250	62
315	62
400	56
500	53
630	49
800	48
1k	44
1k25	41
1k6	39
2k	40
2k5	34
3k15	29
4k	27
5k	26

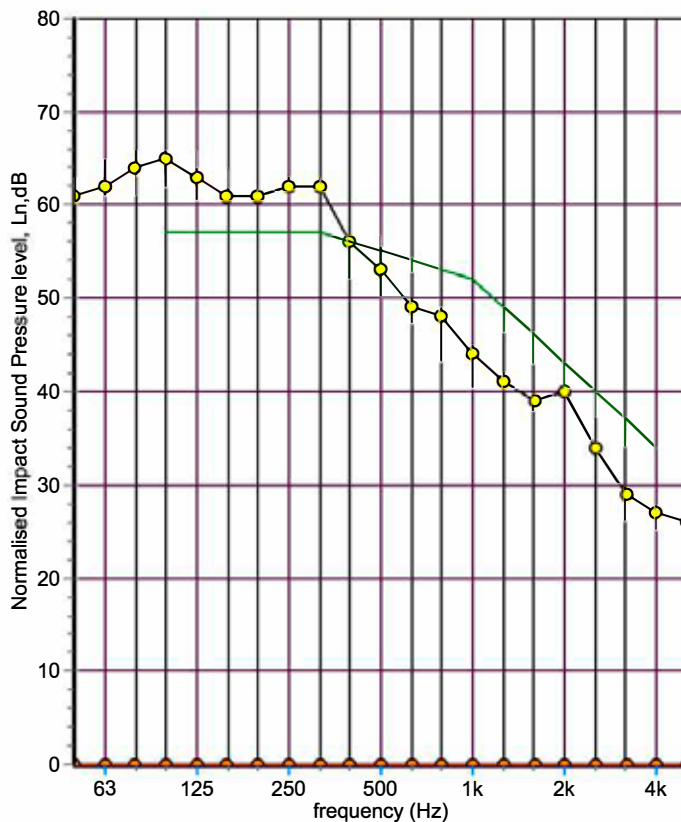

Rating according to ISO 717-2

$L'_{n,w}(C1) = 55 (1) \text{ dB}$

$C_{I,50-2500} = \text{dB}$

Evaluation based on field measurement results obtained in one-third-octave bands by an engineering method

Rating according to ASTM E989-89

Field Impact Insulation Class = 55

No. of test report : 2015159A

Name of test institute : Marshall Day Acoustics

Date : 18 Aug 16

Signature :

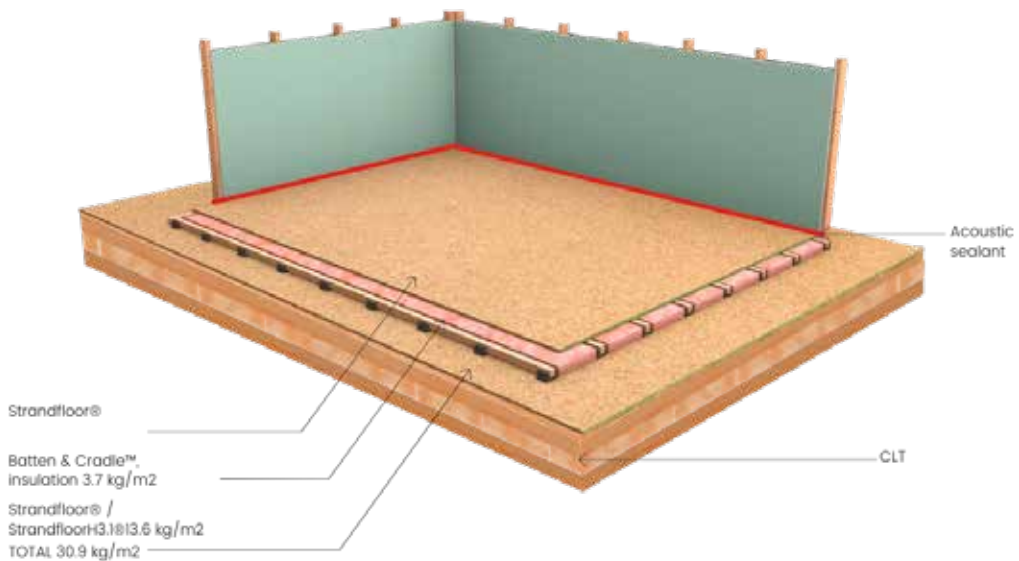
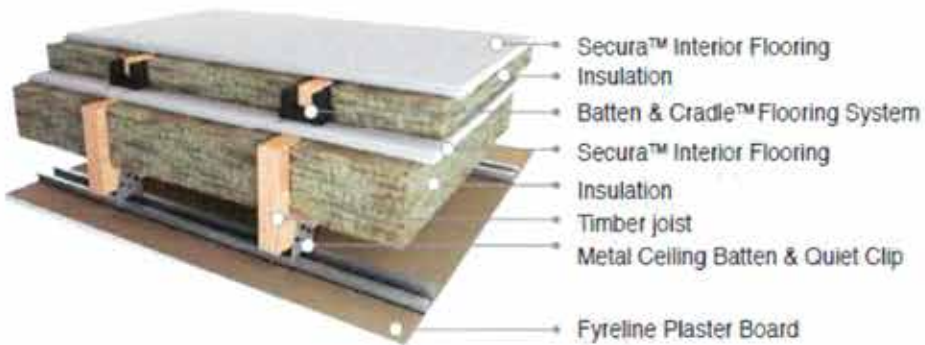
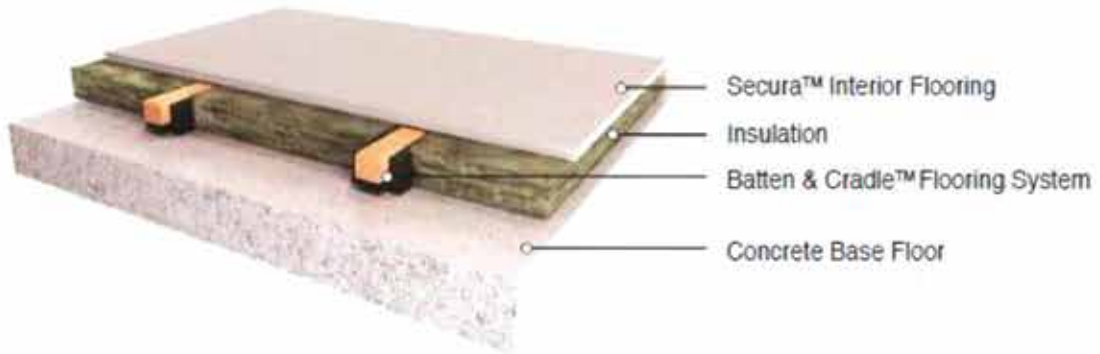





TEST REPORT

ST1046

LOAD TEST ON BATTEN AND CRADLE FLOOR

CLIENT

Batten and Cradle
Level 1,
20-22 Gundry Street
New Zealand

PROJECT NUMBER:

ST1046

ISSUE DATE:

8 October 2014

PAGE:

1 of 12

THE LEGAL VALIDITY OF THIS REPORT CAN ONLY BE CLAIMED ON PRESENTATION OF THE COMPLETE SIGNED PAPER REPORT.
EXTRACTS OR ABRIDGMENTS OF THIS REPORT SHALL NOT BE PUBLISHED WITHOUT PERMISSION FROM BRANZ LTD.

OBJECTIVE

To carry out concentrated load tests on the Batten and Cradle flooring system using James Hardie 19mm Scyon Secura flooring sheets. Loading was in accordance with AS/NZS 1170.1 "Structural design actions. Part 1: Permanent, imposed and other actions". Reference values for floor loads are set out in Table 3.1.

LIMITATION

The results reported here relate only to the item/s tested.

TERMS AND CONDITIONS

This report is issued in accordance with the Terms and Conditions as detailed and agreed in the BRANZ Services Agreement for this work.



REPORT NUMBER:

ST1046

ISSUE DATE:

8 October 2014

PAGE:

2 of 12



THE LEGAL VALIDITY OF THIS REPORT CAN ONLY BE CLAIMED ON PRESENTATION OF THE COMPLETE SIGNED PAPER REPORT.
EXTRACTS OR ABRIDGMENTS OF THIS REPORT SHALL NOT BE PUBLISHED WITHOUT PERMISSION FROM BRANZ LTD.

CONTENTS

SIGNATORIES	5
DOCUMENT REVISION STATUS	5
1. DESCRIPTION OF SPECIMEN	6
1.1 Product description.....	6
1.2 Specimen construction.....	6
2. DESCRIPTION OF TEST	8
2.1 Date and location	8
2.2 Test set-up	8
2.3 Test procedure.....	9
3. OBSERVATIONS AND RESULTS	9



REPORT NUMBER:

ST1046

ISSUE DATE:

8 October 2014

PAGE:

3 of 12



THE LEGAL VALIDITY OF THIS REPORT CAN ONLY BE CLAIMED ON PRESENTATION OF THE COMPLETE SIGNED PAPER REPORT.
EXTRACTS OR ABRIDGMENTS OF THIS REPORT SHALL NOT BE PUBLISHED WITHOUT PERMISSION FROM BRANZ LTD.

FIGURES

Figure 1 Test specimen set up.....	7
Figure 2. Load/deflection plot, test 1	10
Figure 3. Load/deflection plot, test 2	11
Figure 4. Load/deflection plot, test 3	11
Figure 5. Load/deflection plot, test 4	12

TABLES

Table 1. Results summary	12
--------------------------------	----



REPORT NUMBER:

ST1046

ISSUE DATE:

8 October 2014

PAGE:

4 of 12



THE LEGAL VALIDITY OF THIS REPORT CAN ONLY BE CLAIMED ON PRESENTATION OF THE COMPLETE SIGNED PAPER REPORT.
EXTRACTS OR ABRIDGMENTS OF THIS REPORT SHALL NOT BE PUBLISHED WITHOUT PERMISSION FROM BRANZ LTD.

SIGNATORIES



Author

Roger Shelton
Senior Structural Engineer



Reviewer

Asif Iqbal
Structural Engineer

DOCUMENT REVISION STATUS

ISSUE NO.	DATE ISSUED	DESCRIPTION
1	8 October 2014	Initial Issue



REPORT NUMBER:

ST1046

ISSUE DATE:

8 October 2014

PAGE:

5 of 12

THE LEGAL VALIDITY OF THIS REPORT CAN ONLY BE CLAIMED ON PRESENTATION OF THE COMPLETE SIGNED PAPER REPORT. EXTRACTS OR ABRIDGMENTS OF THIS REPORT SHALL NOT BE PUBLISHED WITHOUT PERMISSION FROM BRANZ LTD.

1. DESCRIPTION OF SPECIMEN

1.1 Product description

The Batten and Cradle flooring system is a proprietary flooring system utilising recycled rubber cradles laid on a concrete floor slab. Timber battens are placed in the cradles and flooring sheets are fixed to the battens to provide a substrate for various finishes. The flooring system combined with the base slab has favourable acoustic properties, and is intended for use in situations requiring acoustic separation. Photograph 1 shows the main features of the system.

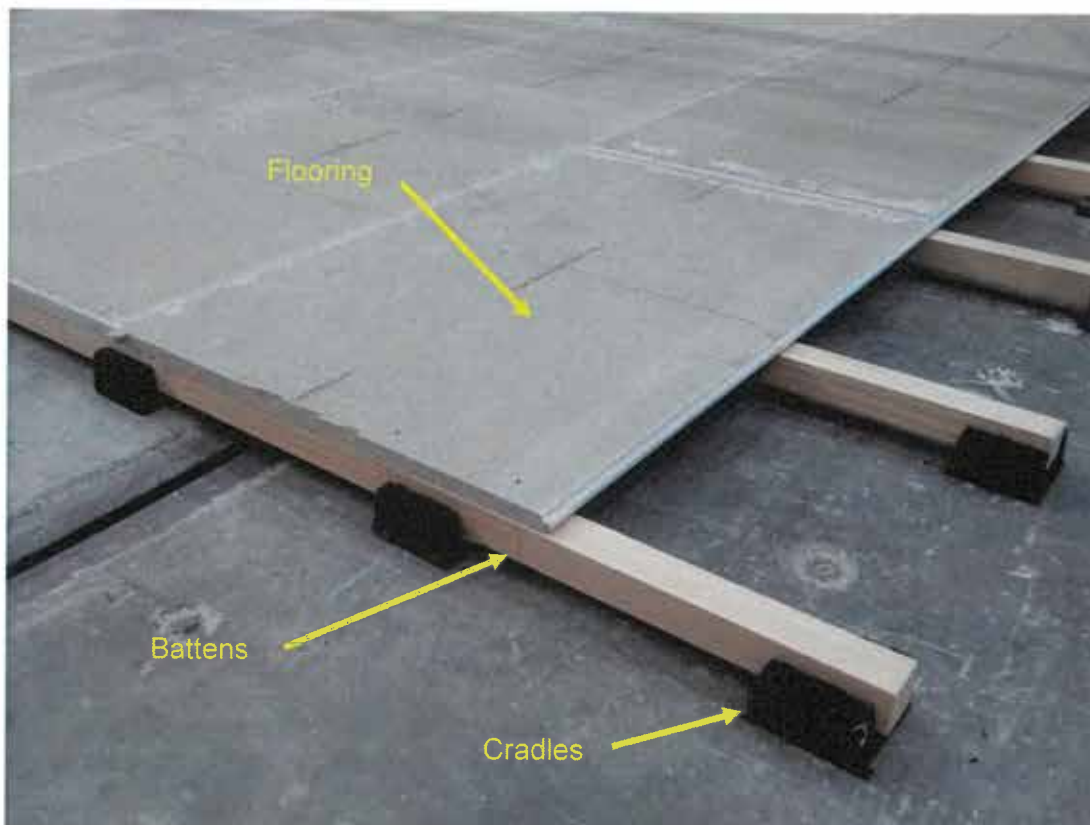

Photograph 1. Main features of Batten and Cradle Floor System

1.2 Specimen construction

A 3.6 m x 2.4 m section of the flooring system was constructed by the client on the floor of the BRANZ Structural Laboratory. Details are shown in Figure 1.



REPORT NUMBER:

ST1046

ISSUE DATE:

8 October 2014

PAGE:

6 of 12



THE LEGAL VALIDITY OF THIS REPORT CAN ONLY BE CLAIMED ON PRESENTATION OF THE COMPLETE SIGNED PAPER REPORT.
EXTRACTS OR ABRIDGMENTS OF THIS REPORT SHALL NOT BE PUBLISHED WITHOUT PERMISSION FROM BRANZ LTD.

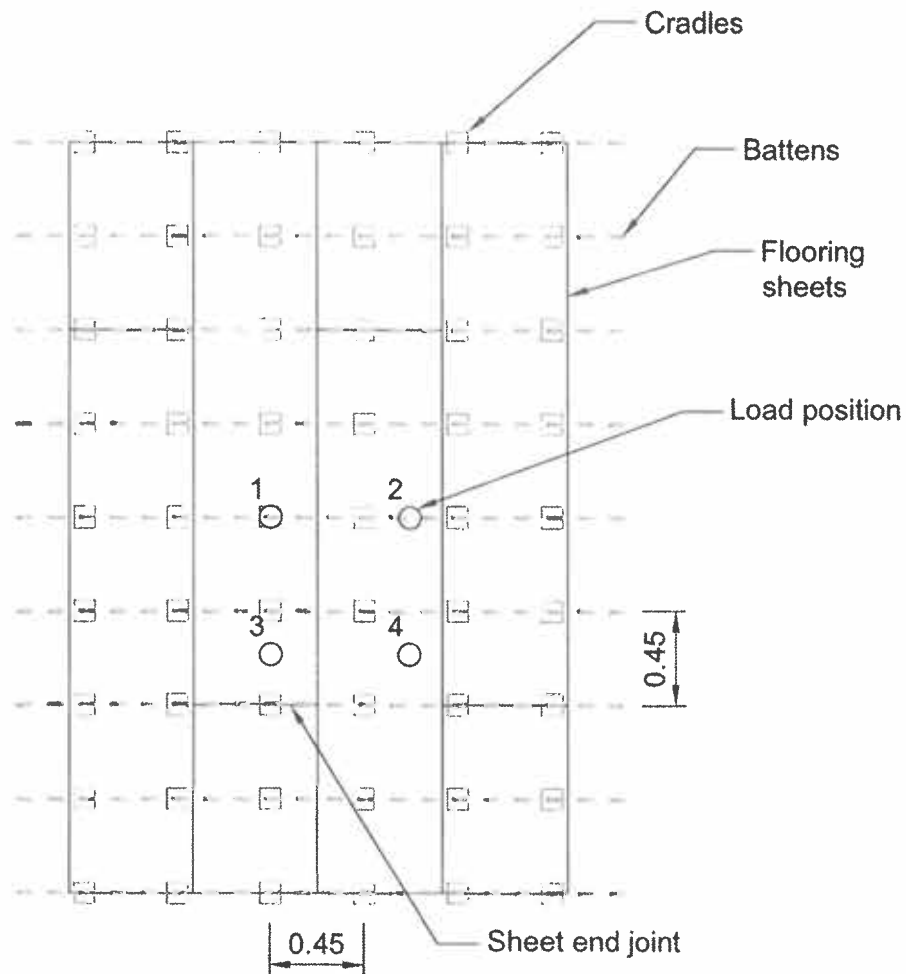

Figure 1 Test specimen set up

Battens were finger jointed Radiata Pine 42 x 42 mm and were not attached to the cradles which were laid directly on the concrete floor. Flooring was James Hardie Scyon Secura sheets, 19 mm thick and 600 mm wide, with long edges machined into a tongue and groove profile. They were cut to length as required to form an offset pattern, and fixed to the battens with 8g screws. Screw spacing was 50 mm from the long edges and 167 mm centres along the batten. The specimen ready for testing is shown in Photograph 2.



REPORT NUMBER:

ST1046

ISSUE DATE:

8 October 2014

PAGE:

7 of 12



THE LEGAL VALIDITY OF THIS REPORT CAN ONLY BE CLAIMED ON PRESENTATION OF THE COMPLETE SIGNED PAPER REPORT. EXTRACTS OR ABRIDGMENTS OF THIS REPORT SHALL NOT BE PUBLISHED WITHOUT PERMISSION FROM BRANZ LTD.



Photograph 2. Specimen ready for test

2. DESCRIPTION OF TEST

2.1 Date and location

The test was conducted on 7th October 2014 at BRANZ Limited laboratories, Judgeford, New Zealand in presence of the client.

2.2 Test set-up

The specimen was set up on the lab floor as described above. A loading gantry was constructed over it and bolted to the lab floor. A hand pumped hydraulic jack was installed on the loading beam together with a 10 kN load cell and a 100 mm diameter loading applicator. AS/NZS 1170.1 states that the concentrated load should be applied over an area of not greater than 0.01 m², which equates to a diameter of 113 mm. The locations of the load application were:

1. Over batten and cradle
2. Over batten between cradles
3. Between battens on cradle lines adjacent sheet butt joint
4. Between battens and cradles.

The locations are shown in Figure 1.



REPORT NUMBER:

ST1046

ISSUE DATE:

8 October 2014

PAGE:

8 of 12



THE LEGAL VALIDITY OF THIS REPORT CAN ONLY BE CLAIMED ON PRESENTATION OF THE COMPLETE SIGNED PAPER REPORT.
EXTRACTS OR ABRIDGMENTS OF THIS REPORT SHALL NOT BE PUBLISHED WITHOUT PERMISSION FROM BRANZ LTD.

Beams supporting deflection gauges were placed across the specimen at the load point and over adjacent battens. The test set up is shown in Photograph 3.



Photograph 3. Test set up

2.3 Test procedure

Load was applied by hand pumped jack gradually increasing up to the 10 kN limit of the load cell. Continuous readings of load and deflection were recorded for analysis.

3. OBSERVATIONS AND RESULTS

Dishing of the flooring around the load application point could quite clearly be seen, and at greater deflections, the joints between the flooring sheets were clearly distorted. Deflections were largely recovered on removal of load, indicating that no inelastic action or permanent effects had occurred. At the end of Test 4 the load applicator punched through the flooring sheet, as shown in Photograph 4. This happened at a load of 10 kN, well above the AS/NZS 1170.1 loading criteria. For “General Office” occupancy the concentrated load criteria is 2.7 kN, and for “Shop floor or retail” occupancy it is 3.6 kN.



REPORT NUMBER:

ST1046

ISSUE DATE:

8 October 2014

PAGE:

9 of 12



THE LEGAL VALIDITY OF THIS REPORT CAN ONLY BE CLAIMED ON PRESENTATION OF THE COMPLETE SIGNED PAPER REPORT.
EXTRACTS OR ABRIDGMENTS OF THIS REPORT SHALL NOT BE PUBLISHED WITHOUT PERMISSION FROM BRANZ LTD.

Plots of load/deflection as recorded are presented in Figures 2 to 5, and a summary is shown in Table 1. Note that “absolute deflection” is the deflection measured relative to the concrete laboratory floor, and “relative deflection” is the deflection of the load point relative to the flooring sheets over the adjacent battens.

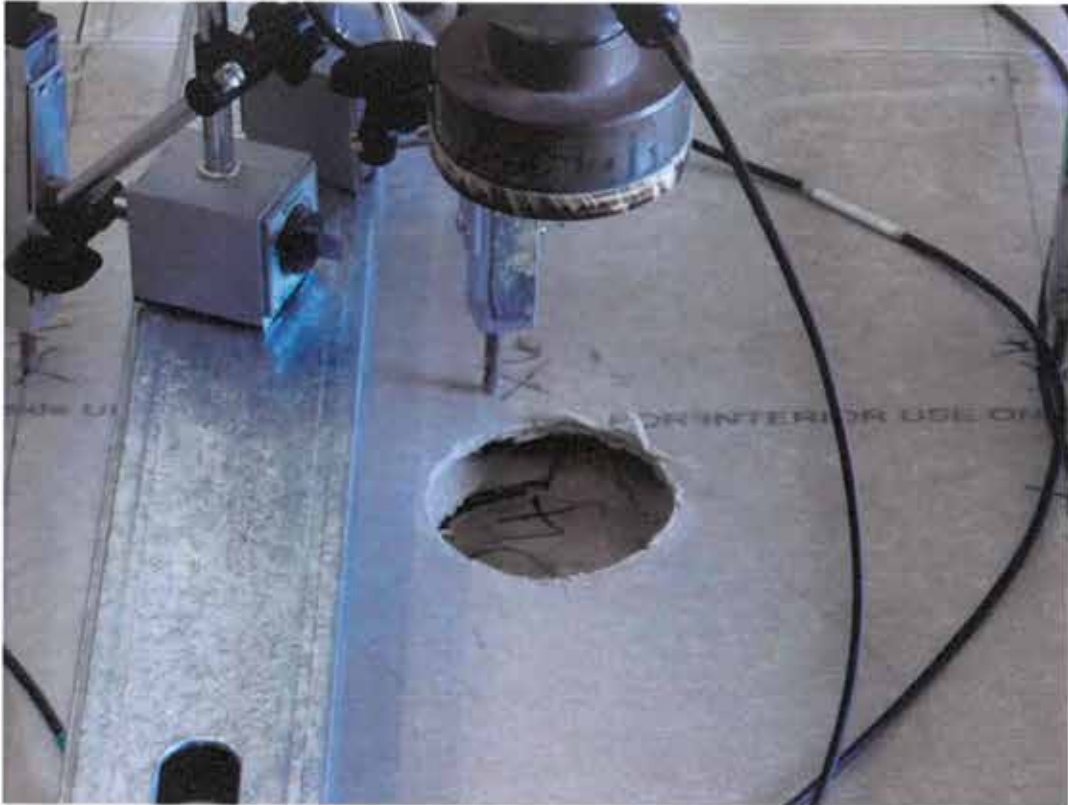

Photograph 4. Punch failure in Test 4



Figure 2. Load/deflection plot, test 1



REPORT NUMBER:

ST1046

ISSUE DATE:

8 October 2014

PAGE:

10 of 12



THE LEGAL VALIDITY OF THIS REPORT CAN ONLY BE CLAIMED ON PRESENTATION OF THE COMPLETE SIGNED PAPER REPORT. EXTRACTS OR ABRIDGMENTS OF THIS REPORT SHALL NOT BE PUBLISHED WITHOUT PERMISSION FROM BRANZ LTD.



Figure 3. Load/deflection plot, test 2

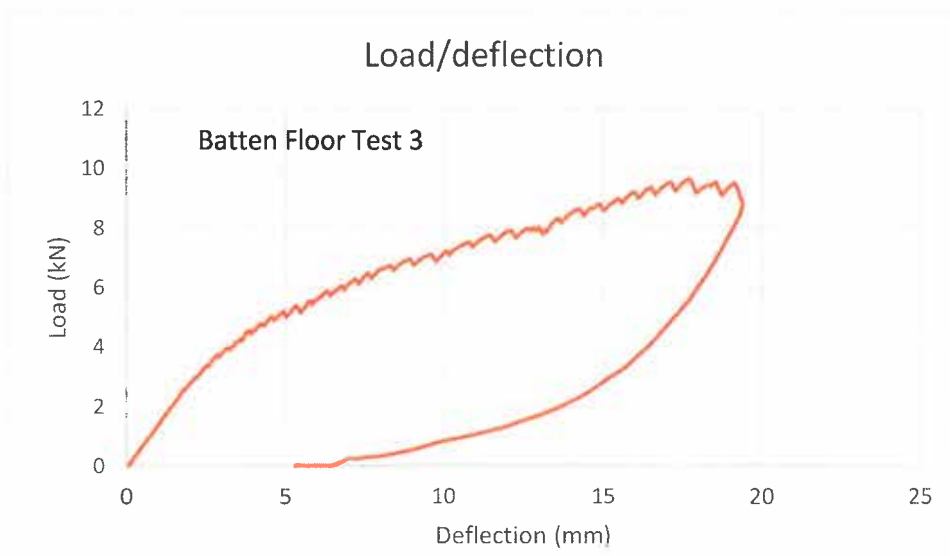

Figure 4. Load/deflection plot, test 3



REPORT NUMBER:

ST1046

ISSUE DATE:

8 October 2014

PAGE:

11 of 12



THE LEGAL VALIDITY OF THIS REPORT CAN ONLY BE CLAIMED ON PRESENTATION OF THE COMPLETE SIGNED PAPER REPORT.
EXTRACTS OR ABRIDGMENTS OF THIS REPORT SHALL NOT BE PUBLISHED WITHOUT PERMISSION FROM BRANZ LTD.

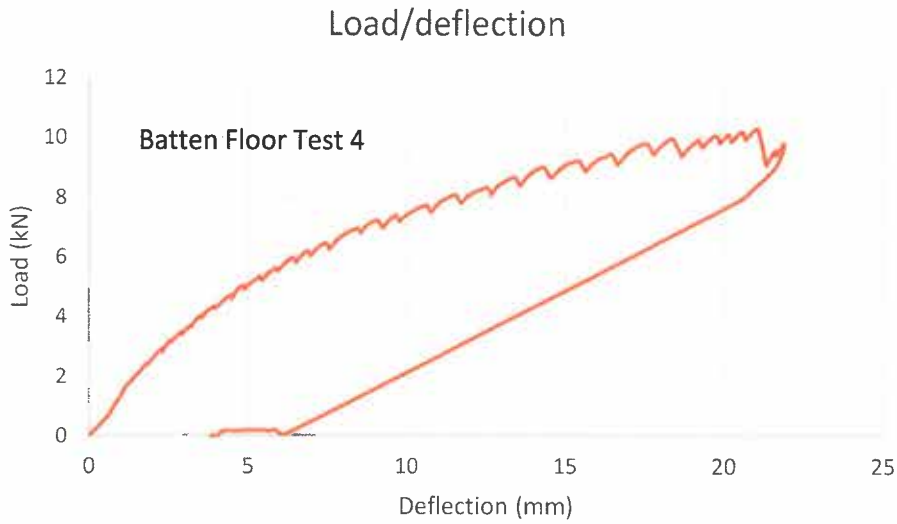

Figure 5. Load/deflection plot, test 4

Test	2.7kN (General Office)		3.6kN (Retail)	
	Absolute	Relative	Absolute	Relative
1	2.7	2.3	3.7	3.1
2	2.6	2.1	3.8	3.0
3	3.4	1.9	4.8	2.7
4	3.7	2.1	5.4	3.1

Table 1. Results summary



REPORT NUMBER:

ST1046

ISSUE DATE:

8 October 2014

PAGE:

12 of 12



THE LEGAL VALIDITY OF THIS REPORT CAN ONLY BE CLAIMED ON PRESENTATION OF THE COMPLETE SIGNED PAPER REPORT.
EXTRACTS OR ABRIDGMENTS OF THIS REPORT SHALL NOT BE PUBLISHED WITHOUT PERMISSION FROM BRANZ LTD.



BRANZ Appraised
Appraisal No. 960 [2017]

**DEKCRADLE™ AND
ERGOFLOR™ TIMBER
FRAMING CRADLES**

 **DekCradle™**



 **ErgoFlor™**



Appraisal No. 960 (2017)

BRANZ Appraisals

Technical Assessments of products
for building and construction.



**B & C Systems
International Limited**

3 Short Lane
New Plymouth
Taranaki 4342
Tel: 06 759 0923

Email: sales@battenandcradle.com
Web: www.battenandcradle.co.nz



BRANZ
1222 Moonshine Rd,
RD1, Porirua 5381
Private Bag 50 908
Porirua 5240,
New Zealand
Tel: 04 237 1170
branz.co.nz



Product

- 1.1 DekCradle and ErgoFlor are rubber cradles used for supporting decking over waterproof membranes or floating floors over internal flooring. They are manufactured from reclaimed and/or recycled rubber.

Scope

- 2.1 DekCradles and ErgoFlor cradles have been appraised for use as supports for timber joists or battens that support decking or internal floating floors.
- 2.2 DekCradles are for use in externally to support decking. ErgoFlor cradles are for use internally to support flooring.

Building Regulations

National Construction Code Series [NCC 2016] Building Code of Australia (BCA)

- 3.1 In the Opinion of BRANZ, DekCradle and ErgoFlor cradles if designed, used, installed and maintained in accordance with the statements and conditions of this Appraisal, will meet or contribute to meeting the following provisions of the BCA:

BCA Volume One – Class 2 to Class 9 Buildings

Part B1 – Structural Provisions: Performance Requirement BP1.1. DekCradle and ErgoFlor cradles meet the requirements for actions arising from the following imposed actions: permanent actions (dead loads) and imposed actions (live loads arising from occupancy and use) [i.e. BP1.1 (b) (i) and (ii)]. See Paragraph 8.1.

BCA Volume 2 – Class 1 and Class 10 Buildings

Part 2.1 – Structure: Performance Requirement P2.1.1. DekCradle and ErgoFlor cradles meet the requirements for actions arising from the following imposed actions: permanent actions (dead loads) and imposed actions (live loads arising from occupancy and use) [i.e. P2.1.1 (b) (i) and (ii)]. See Paragraph 8.1.

Technical Specification

- 4.1 DekCradles and ErgoFlor cradles are manufactured from reclaimed and/or recycled rubber. They are bonded with a blocked resin formulation. The DekCradles are manufactured from brown coloured rubber and the ErgoFlor cradles are manufactured from black rubber with a red fleck. The DekCradles and ErgoFlor cradles are otherwise identical dimensionally, being 90 mm wide, 70 mm long and 40 mm deep. They have a 49 mm wide, 20 mm deep channel running along the 70 mm axis to form the cradle.

Handling and Storage

- 5.1 DekCradles and ErgoFlor cradles are reasonably robust. They should be kept dry before installation, especially the ErgoFlor cradles for use internally.

Technical Literature

- 6.1 Refer to the Appraisals listing on the BRANZ website for details of the current Technical Literature for DekCradle and ErgoFlor. The Technical Literature must be read in conjunction with this Appraisal. All aspects of design, installation, use and maintenance contained in the Technical Literature and within this Appraisal must be followed.

Design Information

General

- 7.1 DekCradles can be used to provide a level and/or elevated deck surface.
- 7.2 DekCradles and ErgoFlor cradles are suitable for use with most waterproofing membranes, however, confirmation as to their suitability should be sought from the membrane supplier.
- 7.3 The supporting structure for the DekCradles or ErgoFlor cradles and associated framing and decking or flooring must be designed to carry the imposed dead load of the floor system along with any associated live load.
- 7.4 DekCradles are not fixed to the substrate that they sit on, so wind uplift of the floating decking may need to be considered. While solid balcony railings and walls provide protection against strong winds, designers and end users need to be aware of uplift from winds in exposed environments.
- 7.5 Battens or joists used with the DekCradles or ErgoFlor cradles must be a minimum of 45 mm wide and 40 mm high.

Structure

- 8.1 When planning the layout of the cradles, the maximum spacing between battens or joists is 400 mm. Cradles must be spaced at no more than 450 mm centres along the battens or joists. When installing DekCradles or ErgoFlor cradles on timber framed decks or floors, they should be placed within 100 mm of the joists below.
- 8.2 At the above spacing DekCradles and ErgoFlor cradles are capable of carrying 2 kPa live load for decks, and 3 kPa live load for floors with minimal deflections. For loads above this, specific design of the underlying structure and the overlying flooring may be required.

Durability

Serviceable Life

- 9.1 The expected serviceable life for the DekCradle and ErgoFlor cradles is at least 15 years.

Maintenance

- 10.1 DekCradle and ErgoFlor cradles should need no maintenance during their serviceable life. In external deck applications allowance should be made to remove built-up debris from the waterproofing surface.

Safety From Falling

- 11.1 Barriers that are required around the perimeter of decks or floors that incorporate DekCradle or ErgoFlor installations must meet the height requirements of BCA Volume 1, D2.16 and Volume 2, P2.5.2 after the installation of the cradles and decking.

Fire

BCA Bushfire Zones

- 12.1 The use of DekCradles and ErgoFlor cradles on buildings located within designated bushfire zones shall be restricted to the requirements of AS 3959.
- 12.2 The Building designer is responsible for determining the Bushfire Attack Level for the building in accordance with AS 3959, which will in turn determine whether the DekCradles or ErgoFlor cradles are suitable for use.

Installation Information

- 13.1 Installation of the DekCradle and ErgoFlor cradles must be in accordance with the Technical Literature.
- 13.2 The site must be clean and free from any waste.
- 13.3 The DekCradle or ErgoFlor cradles must be laid out such that there is no more than 450 mm between cradles along the length of the battens or joists, and no more than 400 mm between the battens or joists. There should be a cradle no more than 50 mm from each end of a batten or joist.
- 13.4 DekCradle and ErgoFlor cradles must not be fixed down to the surface that they are placed upon.
- 13.5 Joists may need to be ripped to make up for variations in floor height or for fall of a deck surface. Alternatively, shims or packers may be used within the cradles. The shim or packer is connected to the batten or joist, not the cradle, with a daub of suitable adhesive. The shim or packer cannot be packed up higher than 10 mm.
- 13.6 Shims or packers used with DekCradles in external locations should be 42 mm wide plastic H packers.
- 13.7 No packing or shims should be placed between DekCradles and the underlying membrane. In internal locations ErgoFlor cradles may be used with packing or shims beneath them as long as the footprint of the packing is larger than the footprint of the ErgoFlor cradle.
- 13.8 Install the decking or flooring following the appropriate building practice and product specifications. All fastenings of the top surface material must be connected to only the battens or joists, not the DekCradle or ErgoFlor, nor to or through the substrate below.

Basis of Appraisal

The following is a summary of the Technical Investigation carried out:

Tests

- 14.1 Compressive testing of the cradles was undertaken by BRANZ Ltd to determine the stiffness of the cradles and their suitability under expected service loads.

Investigations

- 15.1 A structural assessment of the DekCradle and ErgoFlor cradles has been carried out based on the structural testing.
- 15.2 A durability assessment has been carried out on DekCradles and ErgoFlor cradles by BRANZ technical experts.

Quality

- 16.1 The manufacture of DekCradle and ErgoFlor Cradles has been examined by BRANZ and found to be satisfactory.
- 16.2 Quality of supply of the product to the market is the responsibility of B & C Systems International Ltd.
- 16.3 Designers are responsible for the design of the building and incorporating DekCradle and ErgoFlor cradles in accordance with this Appraisal and the Technical Literature.
- 16.4 Quality of installation is the responsibility of the installer.

Sources of Information

- AS 3959 – 2009 Construction of buildings in bushfire-prone areas.
- National Construction Code Series, Building Code of Australia 2016, Australian Building Codes Board.



In the opinion of BRANZ, **DekCradle™ and ErgoFlor Timber Framing Cradles** are fit for purpose and will comply with the Building Code to the extent specified in this Appraisal provided they are used, designed, installed and maintained as set out in this Appraisal.

The Appraisal is issued only to **B & C Systems International Limited**, and is valid until further notice, subject to the Conditions of Appraisal.

Conditions of Appraisal

1. This Appraisal:
 - a) relates only to the product as described herein;
 - b) must be read, considered and used in full together with the Technical Literature;
 - c) does not address any Legislation, Regulations, Codes or Standards, not specifically named herein;
 - d) is copyright of BRANZ.
2. **B & C Systems International Limited**:
 - a) continues to have the product reviewed by BRANZ;
 - b) shall notify BRANZ of any changes in product specification or quality assurance measures prior to the product being marketed;
 - c) abides by the BRANZ Appraisals Services Terms and Conditions.
 - d) Warrants that the product and the manufacturing process for the product are maintained at or above the standards, levels and quality assessed and found satisfactory by BRANZ pursuant to BRANZ's Appraisal of the product.
3. BRANZ makes no representation or warranty as to:
 - a) the nature of individual examples of, batches of, or individual installations of the product, including methods and workmanship;
 - b) the presence or absence of any patent or similar rights subsisting in the product or any other product;
 - c) any guarantee or warranty offered by **B & C Systems International Limited**.
4. Any reference in this Appraisal to any other publication shall be read as a reference to the version of the publication specified in this Appraisal.
5. BRANZ provides no certification, guarantee, indemnity or warranty, to **B & C Systems International Limited** or any third party.

For BRANZ



Chelydra Percy

Chief Executive

Date of Issue:

02 March 2017



BRANZ Appraised
Appraisal No. 945 [2017]

**DEKCRADLE™ AND
ERGOFLOR™ TIMBER
FRAMING CRADLES**

 **DekCradle™**



 **ErgoFlor™**



Appraisal No. 945 [2017]

BRANZ Appraisals

Technical Assessments of products for building and construction.



B & C Systems International Limited

3 Short Lane
New Plymouth
Taranaki 4342
Tel: 06 759 0923

Email: sales@battenandcradle.com
Web: www.battenandcradle.co.nz



BRANZ
1222 Moonshine Rd,
RD1, Porirua 5381
Private Bag 50 908
Porirua 5240,
New Zealand
Tel: 04 237 1170
branz.co.nz



Product

- 1.1 DekCradle and ErgoFlor are rubber cradles used for supporting decking over waterproof membranes or floating floors over internal flooring. They are manufactured from reclaimed and/or recycled rubber.

Scope

- 2.1 DekCradles and ErgoFlor cradles have been appraised for use as supports for timber joists or battens that support decking or internal floating floors.
- 2.2 DekCradles are for use externally to support decking. ErgoFlor cradles are for use internally to support flooring.

Building Regulations

New Zealand Building Code (NZBC)

- 3.1 In the Opinion of BRANZ, DekCradle and ErgoFlor cradles if designed, used, installed and maintained in accordance with the statements and conditions of this Appraisal, will meet or contribute to meeting the following provisions of the NZBC:

Clause B1 STRUCTURE: Performance B1.3.1, B1.3.2 and B1.3.4. DekCradle and ErgoFlor meet the requirements for loads arising from self-weight and imposed gravity loads arising from use [i.e. B.1.3.3 [a] and [b]]. See paragraphs 8.1 and 8.2.

Clause B2 DURABILITY: Performance B2.3.1 [b] 15 years, and B2.3.1 [c] 5 years. DekCradle and ErgoFlor cradles meet this requirement. See paragraph 9.1.

Clause F2 HAZARDOUS BUILDING MATERIALS: Performance F2.3.1. DekCradle and ErgoFlor cradles meet this requirement and will not present a health hazard to people.

Technical Specification

- 4.1 DekCradles and ErgoFlor cradles are manufactured from reclaimed and/or recycled rubber. They are bonded with a blocked resin formulation. The DekCradles are manufactured from brown coloured rubber and the ErgoFlor cradles are manufactured from black rubber with a red fleck. The DekCradles and ErgoFlor cradles are otherwise identical dimensionally, being 90 mm wide, 70 mm long and 40 mm deep. They have a 49 mm wide, 20 mm deep channel running along the 70 mm axis to form the cradle.

Handling and Storage

- 5.1 DekCradles and ErgoFlor cradles are reasonably robust. They should be kept dry before installation, especially the ErgoFlor cradles for use internally.

Technical Literature

- 6.1 Refer to the Appraisals listing on the BRANZ website for details of the current Technical Literature for DekCradle and ErgoFlor. The Technical Literature must be read in conjunction with this Appraisal. All aspects of design, installation, use and maintenance contained in the Technical Literature and within this Appraisal must be followed.

Design Information

General

- 7.1 DekCradles can be used to provide a level and/or elevated deck surface. They may be used to meet the requirements for level thresholds as described in NZBC Acceptable Solution E2/AS1, Clause 7.3.
- 7.2 DekCradles provide a means of supporting decking to provide protection to waterproofing membranes. DekCradles are suitable for use with most waterproofing membranes, however, confirmation as to their suitability should be sought from the membrane supplier.
- 7.3 The supporting structure for the DekCradles or ErgoFlor cradles and associated framing and decking or flooring must be designed to carry the imposed dead load of the floor/deck system along with any associated live load.
- 7.4 DekCradles are not fixed to the substrate that they sit on, so wind uplift of floating decking may need to be considered. While solid balcony railings and walls provide protection against strong winds, designers and end users need to be aware of uplift from winds in exposed environments.
- 7.5 Battens or joists used with the DekCradles or ErgoFlor cradles must be a minimum of 45 mm wide and 40 mm high.

Structure

- 8.1 When planning the layout of the cradles, the maximum spacing between battens or joists is 400 mm. Cradles must be spaced at no more than 450 mm centres along the battens or joists. When installing DekCradles or ErgoFlor cradles on timber framed decks or floors they should be placed within 100 mm of the joists below.
- 8.2 At the above spacing DekCradles and ErgoFlor cradles are capable of carrying 2 kPa live load for decks, and 3 kPa live load for floors with minimal deflections. For loads above this, specific design of the underlying structure and the overlying flooring may be required.

Durability

Serviceable Life

- 9.1 The expected serviceable life for the DekCradle and ErgoFlor cradles is at least 15 years.

Maintenance

- 10.1 DekCradle and ErgoFlor cradles should need no maintenance during their serviceable life. In external deck applications allowance should be made to remove built-up debris from the waterproofing surface.

Safety From Falling

- 11.1 Barriers that are required around the perimeter of decks or floors that incorporate DekCradle or ErgoFlor installations must meet the height requirements of New Zealand Building Code Acceptable Solution F4/AS1 after the installation of the cradles and decking or flooring.

Installation Information

- 12.1 Installation of the DekCradle and ErgoFlor cradles must be in accordance with the Technical Literature.
- 12.2 The site must be clean and free from any waste.
- 12.3 The DekCradle or ErgoFlor cradles must be laid out such that there is no more than 450 mm between cradles along the length of the battens or joists, and no more than 400 mm between the battens or joists. There should be a cradle no more than 50 mm from each end of a batten or joist.
- 12.4 DekCradle and ErgoFlor cradles must not be fixed down to the surface that they are placed upon.
- 12.5 Joists may need to be ripped to make up for variations in floor height or for fall of a deck surface. Alternatively, shims or packers may be used within the cradles. The shim or packer is connected to the batten or joist, not the cradle, with a daub of suitable adhesive. The shim or packer cannot be packed up higher than 10 mm.
- 12.6 Shims or packers used with DekCradles in external locations should be 42 mm wide plastic H packers.
- 12.7 No packing or shims should be placed between DekCradles and the underlying surface. In internal locations ErgoFlor cradles may be used with packing or shims beneath them as long as the footprint of the packing is larger than the footprint of the ErgoFlor cradle.
- 12.8 Install the decking or flooring following the appropriate building practice and product specifications. All fastenings of the top surface material must be connected to only the battens or joists, not the DekCradle or ErgoFlor, nor to or through the substrate below.

Basis of Appraisal

The following is a summary of the Technical Investigation carried out:

Tests

- 13.1 Compressive testing of the cradles was undertaken by BRANZ Ltd to determine the stiffness of the cradles and their suitability under expected service loads.

Investigations

- 14.1 A structural assessment of the DekCradle and ErgoFlor cradles has been carried out based on the structural testing.
- 14.2 A durability assessment has been carried out on DekCradles and ErgoFlor cradles by BRANZ technical experts.

Quality

- 15.1 The manufacture of DekCradle and ErgoFlor Cradles has been examined by BRANZ and found to be satisfactory.
- 15.2 Quality of supply of the product to the market is the responsibility of B & C Systems International Ltd.
- 15.3 Designers are responsible for the design of the building and incorporating DekCradle and ErgoFlor cradles in accordance with this Appraisal and the Technical Literature.
- 15.4 Quality of installation is the responsibility of the installer.

Sources of Information

- NZS 3604:2011 Timber-framed buildings.
- Ministry of Business, Innovation and Employment Record of Amendments for Compliance Documents and Handbooks.
- The Building Regulations 1992.



In the opinion of BRANZ, **DekCradle™ and ErgoFlor Timber Framing Cradles** are fit for purpose and will comply with the Building Code to the extent specified in this Appraisal provided they are used, designed, installed and maintained as set out in this Appraisal.

The Appraisal is issued only to **B & C Systems International Limited**, and is valid until further notice, subject to the Conditions of Appraisal.

Conditions of Appraisal

1. This Appraisal:
 - a) relates only to the product as described herein;
 - b) must be read, considered and used in full together with the Technical Literature;
 - c) does not address any Legislation, Regulations, Codes or Standards, not specifically named herein;
 - d) is copyright of BRANZ.
2. **B & C Systems International Limited**:
 - a) continues to have the product reviewed by BRANZ;
 - b) shall notify BRANZ of any changes in product specification or quality assurance measures prior to the product being marketed;
 - c) abides by the BRANZ Appraisals Services Terms and Conditions.
 - d) Warrants that the product and the manufacturing process for the product are maintained at or above the standards, levels and quality assessed and found satisfactory by BRANZ pursuant to BRANZ's Appraisal of the product.
3. BRANZ makes no representation or warranty as to:
 - a) the nature of individual examples of, batches of, or individual installations of the product, including methods and workmanship;
 - b) the presence or absence of any patent or similar rights subsisting in the product or any other product;
 - c) any guarantee or warranty offered by **B & C Systems International Limited**.
4. Any reference in this Appraisal to any other publication shall be read as a reference to the version of the publication specified in this Appraisal.
5. BRANZ provides no certification, guarantee, indemnity or warranty, to **B & C Systems International Limited** or any third party.

For BRANZ



Chelydra Percy
Chief Executive
02 March 2017



www.battenandcradle.co.nz



www.battenandcradle.com.au

